



TEL: 800.BRADLEY
FAX: 262.251.5817
bradleycorp.com

Valve List Price Book 0224VSP

Effective Date February 1, 2024

Table of Contents

Introduction	2
Emergency Thermostatic Mixing Valves	3
Digital Mixing Valves	4
Digital Recirculation Stations	5
Hi-Low Thermostatic Mixing Valves	6 & 7
Hi-Low High Capacity Systems	8
High-Low Recirculation Stations	9
Standard Thermostatic Mixing Valves	10 & 11
Point-Of-Use Thermostatic Mixing Valves	12 & 13
Tepid Water System	14



PRICES This price list applies from its effective date and all prior corresponding price lists are canceled. Prices are subject to change without notice. Items may be changed or discontinued without notice and without incurring obligation. For job quotations, please contact your Bradley Sales Representative in your area.

Credit Terms Open Account Terms are Net 30 days from date of invoice. Past due accounts may be subject to a service charge. Settlement of past due invoices may be required before additional shipments will be made. Cash in advance may be required when open accounts are not approved. Credit Department Phone 1-800-BRADLEY, FAX (262) 251-7747.

MINIMUM ORDERS Orders under \$100.00 net will incur a \$15.00 service charge.

**RETURN
MERCHANDISE
AUTHORIZATION AND
CANCELLATIONS** Bradley shall provide Return Materials Authorization (RMA) to original purchaser for all authorized returns. It shall be the responsibility of the original purchaser to obtain written RMA authorization to return merchandise for credit. Materials must be in the original packaging and in resalable as new condition. Items returned without RMA information provided will be refused and returned for delivery back to sender at sender's expense freight collect. A minimum of 25% handling and restocking charge (or \$50.00, whichever is greater) is required on all returns. Standard fixtures will be considered for return. Other custom-fabricated modified fixtures and special fixture items will not be considered for return, and are non-cancelable when entered by Bradley.

Please refer to our policy at <http://www.bradleycorp.com/customerservice/rma> for details.

**SHIPMENTS AND
CLAIMS** Transit damage should be noted on the freight bill before signing for receipt of material. Bradley should be notified by FAX immediately. Bradley will then file the claim with the contracted carrier as a service to the customer.
Claims for shipment shortages must be FAXed within two (2) weeks of invoice date to Bradley with documentation and are subject to factory verification.

**TECHNICAL
ASSISTANCE** Your Bradley Sales Representative can provide technical or promotional information on Bradley Products. They are specialists in the field.

WARRANTY Product warranties may be found under "Product Information" on our website at www.bradleycorp.com



Navigator® Thermostatic Mixing Valves - Emergency Fixtures

THERMOSTATIC MIXING VALVES						
Model No.	Description	Inlet Size	Outlet Size	GPM	Ship Wt. (lbs)	List Price
S19-2000	EFX8 Thermostatic Mixing Valve	1/2"	1/2"	1.5-10.5	10	\$1,113.00
S19-2000EFX	EFX8 for Cabinet Mount Eyewash	1/2"	1/2"	1.5-10.5	10	\$1,204.00
S19-2100	EFX25 Thermostatic Mixing Valve	3/4"	1"	2.0-37.0	20	\$1,948.00
S19-2150	EFX20 Thermostatic Mixing Valve	3/4"	1"	3.0-30.5	20	\$1,862.00
S19-2200	EFX60 Thermostatic Mixing Valve	1"	1 1/4"	2.0-75.5	30	\$2,691.00
S19-2250	EFX50 Thermostatic Mixing Valve	1"	1 1/4"	3.0-65.0	30	\$2,569.00
S19-2300	EFX125 Thermostatic Mixing Valve	1 1/4"	1 1/2"	3.0-116.0	40	\$3,563.00
S19-2350	EFX120 Thermostatic Mixing Valve	1 1/4"	1 1/2"	3.0-107.0	40	\$3,405.00

OPTIONAL SELECTIONS						
Add price for appropriate option to thermostatic valve price above				Sample: EFX25 - C		
Model No.	Description	Rough Brass	Chrome Plated	Bracket		
Option Code		R	C	B		
S19-2000	EFX8 Thermostatic Mixing Valve	N/C	\$208.00	\$55.00		
S19-2100	EFX25 Thermostatic Mixing Valve	N/C	\$290.00	\$65.00		
S19-2150	EFX20 Thermostatic Mixing Valve	N/C	\$290.00	\$65.00		
S19-2200	EFX60 Thermostatic Mixing Valve	N/C	\$290.00	\$65.00		
S19-2250	EFX50 Thermostatic Mixing Valve	N/C	\$290.00	\$65.00		
S19-2300	EFX125 Thermostatic Mixing Valve	N/C	\$290.00	\$70.00		
S19-2350	EFX120 Thermostatic Mixing Valve	N/C	\$290.00	\$70.00		

CABINETS, PIPED ASSEMBLY, AND WINDOW OPTION						
Add price for appropriate option to thermostatic valve price above				Sample: CAB-EFX25-RS		
N Piped Assembly required for Cabinet selection				Sample: EFX25 - P - RS		
Cabinet only option does not include valve or piped assembly						
Must specify cabinet option code and piping option code with order						
Valve	Option	Description	Ship Wt. (lbs)	Cabinet-Only	Inlet & Outlet Shut Off Valves	No Inlet & Outlet Shut-Off Valves
				CAB-EFX	P	N

EFX8	SS	Surface Mount Stainless Steel Cabinet w/ Piping	10	\$804.00	---	\$820.00
	RS	Recessed Stainless Steel Cabinet w/ Piping	10	\$953.00	---	\$968.00
	SE	Surface Mount White Enamel Cabinet w/ Piping	10	\$804.00	---	\$820.00
	RE	Recessed White Enamel Cabinet w/ Piping	10	\$953.00	---	\$968.00
EFX25 EFX20	P or N	P or N Piped Assembly	5	---	\$757.00	---
	SS	Surface Mount Stainless Steel Cabinet w/ Piping	25	\$1,397.00	\$2,219.00	\$1,537.00
	RS	Recessed Stainless Steel Cabinet w/ Piping	25	\$1,477.00	\$2,302.00	\$1,618.00
	SE	Surface Mount White Enamel Cabinet w/ Piping	25	\$1,397.00	\$2,219.00	\$1,537.00
EFX60 EFX50	RE	Recessed White Enamel Cabinet w/ Piping	25	\$1,477.00	\$2,302.00	\$1,618.00
	P or N	P or N Piped Assembly	10	---	\$989.00	---
	SS	Surface Mount Stainless Steel Cabinet w/ Piping	40	\$1,451.00	\$2,514.00	\$1,687.00
	RS	Recessed Stainless Steel Cabinet w/ Piping	40	\$1,593.00	\$2,660.00	\$1,829.00
EFX125 EFX120	SE	Surface Mount White Enamel Cabinet w/ Piping	40	\$1,451.00	\$2,514.00	\$1,687.00
	RE	Recessed White Enamel Cabinet w/ Piping	40	\$1,593.00	\$2,660.00	\$1,829.00
	P or N	P or N Piped Assembly	10	---	\$1,273.00	---
	SS	Surface Mount Stainless Steel Cabinet w/ Piping	40	\$1,464.00	\$2,818.00	\$2,087.00
W	RS	Recessed Stainless Steel Cabinet w/ Piping	40	\$1,681.00	\$3,042.00	\$2,305.00
	SE	Surface Mount White Enamel Cabinet w/ Piping	40	\$1,464.00	\$2,818.00	\$2,087.00
	RE	Recessed White Enamel Cabinet w/ Piping	40	\$1,681.00	\$3,042.00	\$2,305.00
	W	Plexiglass Window in Door		\$246.00	\$246.00	\$246.00

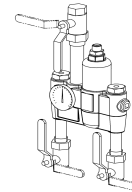

EFX2

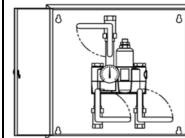

EFX25-



List Price

Effective Date February 1, 2024

Navigator Digital Mixing Valves

DIGITAL MIXING VALVES						
Model No.	Description	Inlet Size	Outlet Size	GPM	Ship Wt. (lbs)	List Price
NRG75	Navigator Digital Mixing Valve (S59-5075)	3/4"	3/4"	2.0-70.0	5.1	\$4,293.00
NRG100	Navigator Digital Mixing Valve (S59-5100)	1"	1"	3.0-150.0	7.3	\$5,288.00
NRG125	Navigator Digital Mixing Valve (S59-5125)	1-1/4"	1-1/4"	4.0-183.0	8.2	\$5,710.00
NRG150	Navigator Digital Mixing Valve (S59-5150)	1-1/2"	1-1/2"	7.0-328.0	21	\$6,294.00
NRG200	Navigator Digital Mixing Valve (S59-5200)	2"	2"	9.0-354.0	22	\$6,645.00

HIGH CAPACITY DIGITAL MIXING VALVE						
Model No.	Description	Inlet Size	Outlet Size	GPM	Ship Wt. (lbs)	List Price
NRG300	Navigator Digital Mixing Valve High Capacity Manifold System (S59-5300)	3"	3"	18.0-658.0	42	\$28,567.00





TEL: 1-800-BRADLEY FAX: 262-251-5817
 Web Site: www.bradleycorp.com

List Price

Effective Date February 1, 2024

Navigator Digital Recirculation Stations

DIGITAL RECIRCULATION MIXING VALVES						
Model No.	Description	Inlet Size	Outlet Size	GPM	Ship Wt. (lbs)	List Price
NRS-D7	Navigator Digital Recirculation Station with NRG75	3/4"	3/4"	\$160.00	160	\$13,519.00
NRS-D10	Navigator Digital Recirculation Station with NRG100	1"	1"	3.0-150.0	170	\$16,223.00
NRS-D12	Navigator Digital Recirculation Station with NRG120	1-1/4"	1-1/4"	4.0-183.0	180	\$17,845.00
NRS-D15	Navigator Digital Recirculation Station with NRG150	1-1/2"	1-1/2"	7.0-328.0	190	\$20,008.00
NRS-D20	Navigator Digital Recirculation Station with NRG200	2"	2"	9.0-354.0	200	\$22,712.00

HIGH CAPACITY DIGITAL RECIRCULATION MIXING VALVE						
Model No.	Description	Inlet Size	Outlet Size	GPM	Ship Wt. (lbs)	List Price
NRS-D30	Navigator Digital High Capacity Recirculation Station with (2) NRG200	3"	3"	18.0-658.0	300	\$40,556.00

STANDARD SELECTIONS						
Add price for appropriate selection to thermostatic valve price above						
Recirculation Pump:						List Price
RP2	Bell & Gossett NBF-9U					\$1,264.00
RP3	Bell & Gossett PL-30B					\$1,944.00
RP4	Bell & Gossett PL-36B					\$2,196.00
RP5	Bell & Gossett PL-55B					\$3,024.00
RP6	Taco 008-SF6-IFC					\$1,796.00
RP7	Taco 009-SF5-IFC					\$2,208.00
RP8	Taco 0013-SF3-IFC					\$2,592.00
RP	Other Pump (Please Provide Manufacturer and Model #)					Contact Bradley for Pricing

Return Line:						List Price
R1	3/4" Return Line					N/C
R2	1" Return Line					\$783.00
R3	1-1/4" Return Line					\$1,407.00
R4	1-1/2" Return Line					\$1,899.00
R5	2" Return Line					\$2,465.00

Prices subject to change without notice.
 Items may be changed or discontinued
 without notice and without incurring obligation.



List Price

Effective Date February 1, 2024

Navigator High-Low Thermostatic Mixing Valves

THERMOSTATIC MIXING VALVES						
Model No.	Description	Inlet Size	Outlet Size	GPM	Ship Wt. (lbs)	List Price
S59-3045	HL45 Thermostatic Mixing Valve	3/4"	1"	1.5-47.0	18	\$3,595.00
S59-3080	HL80 Thermostatic Mixing Valve	1"	1 1/4"	2.0-77.0	25	\$4,699.00
S59-3130	HL130 Thermostatic Mixing Valve	1 1/4"	1 1/2"	4.0-126.0	40	\$5,496.00
S59-3200	HL200 Thermostatic Mixing Valve	2"	2"	5.0-192.0	50	\$6,059.00

OPTIONAL SELECTIONS						
Add price for appropriate option to thermostatic valve price above				Sample: <u>HL45 - B</u>		
Model No.	Description	Rough Brass	Chrome Plated	Standard-Range Thermostat	High-Range Thermostat	Bracket
Option Code		R	C	S	H	B
S59-3045	HL45 Thermostatic Mixing Valve	N/C	\$271.00	N/C	N/C	\$65.00
S59-3080	HL80 Thermostatic Mixing Valve	N/C	\$271.00	N/C	N/C	\$65.00
S59-3130	HL130 Thermostatic Mixing Valve	N/C	\$290.00	N/C	N/C	\$70.00
S59-3200	HL200 Thermostatic Mixing Valve	N/C	\$290.00	N/C	N/C	\$83.00

* For cabinets, piped assemblies, and window options see the following page

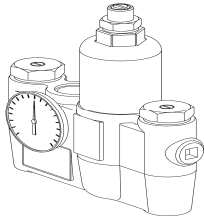

S59-3045

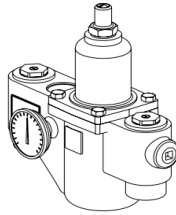

S59-3130

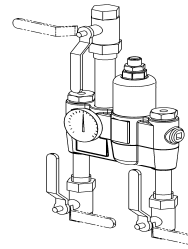

HL45-P



List Price

Effective Date February 1, 2024

Navigator High-Low Thermostatic Mixing Valves

CABINETS, PIPED ASSEMBLY, AND WINDOW OPTIONS

Add price for appropriate option to thermostatic valve price

Cabinet only option does not include valve or piped assembly

Sample: CAB-HL45- RS

Must specify cabinet option code and piping option code with order.

Sample: HL45 - P - RS

Cabinet prices include price for select pipe assembly

Valve	Option	Description	Ship Wt. (lbs)	Cabinet Only	Inlet & Outlet Shut Off Valves	Outlet Shut Off Valve Only
				CAB-HL	P	N
HL45 CAB-HL45	P or N	P or N Piped Assembly	5	---	\$757.00	\$421.00
	SS	Surface Mount Stainless Steel Cabinet w/ Piping	10	\$1,397.00	\$2,219.00	\$1,872.00
	RS	Recessed Stainless Steel Cabinet w/ Piping	10	\$1,477.00	\$2,302.00	\$1,955.00
	SE	Surface Mount White Enamel Cabinet w/ Piping	10	\$1,397.00	\$2,219.00	\$1,872.00
	RE	Recessed White Enamel Cabinet w/ Piping	10	\$1,477.00	\$2,302.00	\$1,955.00
HL80 CAB-HL80	P or N	P or N Piped Assembly	5	---	\$989.00	\$498.00
	SS	Surface Mount Stainless Steel Cabinet w/ Piping	10	\$1,451.00	\$2,514.00	\$2,008.00
	RS	Recessed Stainless Steel Cabinet w/ Piping	10	\$1,593.00	\$2,660.00	\$2,154.00
	SE	Surface Mount White Enamel Cabinet w/ Piping	10	\$1,451.00	\$2,514.00	\$2,008.00
	RE	Recessed White Enamel Cabinet w/ Piping	10	\$1,593.00	\$2,660.00	\$2,154.00
HL130 CAB-HL130	P or N	P or N Piped Assembly	10	---	\$1,273.00	\$637.00
	SS	Surface Mount Stainless Steel Cabinet w/ Piping	25	\$1,464.00	\$2,818.00	\$2,164.00
	RS	Recessed Stainless Steel Cabinet w/ Piping	25	\$1,681.00	\$3,042.00	\$2,388.00
	SE	Surface Mount White Enamel Cabinet w/ Piping	25	\$1,464.00	\$2,818.00	\$2,164.00
	RE	Recessed White Enamel Cabinet w/ Piping	25	\$1,681.00	\$3,042.00	\$2,388.00
HL200 CAB-HL200	P or N	P or N Piped Assembly (chrome plating not available)	10	---	\$1,589.00	\$794.00
	SS	Surface Mount Stainless Steel Cabinet w/ Piping	25	\$1,535.00	\$3,217.00	\$2,399.00
	RS	Recessed Stainless Steel Cabinet w/ Piping	25	\$1,699.00	\$3,386.00	\$2,567.00
	SE	Surface Mount White Enamel Cabinet w/ Piping	25	\$1,535.00	\$3,217.00	\$2,399.00
	RE	Recessed White Enamel Cabinet w/ Piping	25	\$1,699.00	\$3,386.00	\$2,567.00
	W	Plexiglass Window in Door		\$246.00	\$246.00	\$246.00

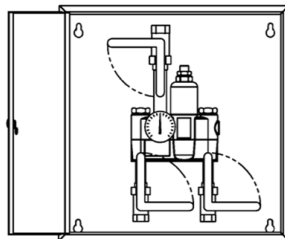

HL45-P-SS



List Price

Effective Date February 1, 2024

Navigator High-Low Thermostatic Mixing Valves - High Capacity Manifold System

HL 2x1 HIGH CAPACITY THERMOSTATIC MIXING VALVES						
Model No.	Description	Inlet Size	Outlet Size	GPM	Ship Wt. (lbs)	List Price
S59-3260	HL2X1 Thermostatic Mixing Valve Assembly	2"	2"	8.0-252.0	185	\$13,916.00
S59-3260H	HL2x1 with High Range Thermostat	2"	2"	8.0-252.0	185	\$13,916.00
S59-3260T	HL2x1 with Thermometer on Combined Outlet	2"	2"	8.0-252.0	185	\$14,093.00
S59-3260HT	HL2x1 with High Range Thermostat and Thermometer on Combined Outlet	2"	2"	8.0-252.0	185	\$14,093.00

HL 2x1 HIGH CAPACITY THERMOSTATIC MIXING VALVES W/ UNI-STRUT						
Model No.	Description	Inlet Size	Outlet Size	GPM	Ship Wt. (lbs)	List Price
S59-3260U	HL2X1 Mounted to Unit-Strut	2"	2"	8.0-252.0	185	\$14,274.00
S59-3260HU	HL2X1 with High Range Thermostat and Mounted to Unit-Strut	2"	2"	8.0-252.0	185	\$14,274.00
S59-3260TU	HL2X1 with Thermometer on Combined Outlet and Mounted to Unit-Strut	2"	2"	8.0-252.0	185	\$14,449.00
S59-3260HTU	HL2X1 with High Range Thermostat, Thermometer on Combined Outlet, and Mounted to Unit-Strut	2"	2"	8.0-252.0	185	\$14,449.00

HL 2x2 HIGH CAPACITY THERMOSTATIC MIXING VALVES						
Model No.	Description	Inlet Size	Outlet Size	GPM	Ship Wt. (lbs)	List Price
S59-3400	HL2X2 Thermostatic Mixing Valve Assembly	3"	3"	10.0-384.0	274	\$18,722.00
S59-3400H	HL2x2 with High Range Thermostat	3"	3"	10.0-384.0	275	\$18,722.00
S59-3400T	HL2x2 with Thermometer on Combined Outlet	3"	3"	10.0-384.0	275	\$19,054.00
S59-3400HT	HL2x2 with High Range Thermostat and Thermometer on Combined Outlet	3"	3"	10.0-384.0	275	\$19,054.00

HL 2x2 HIGH CAPACITY THERMOSTATIC MIXING VALVES W/ UNI-STRUT						
Model No.	Description	Inlet Size	Outlet Size	GPM	Ship Wt. (lbs)	List Price
S59-3400U	HL2X2 Mounted to Unit-Strut	3"	3"	10.0-384.0	275	\$19,077.00
S59-3400HU	HL2X2 with High Range Thermostat and Mounted to Unit-Strut	3"	3"	10.0-384.0	275	\$19,077.00
S59-3400TU	HL2X2 with Thermometer on Combined Outlet and Mounted to Unit-Strut	3"	3"	10.0-384.0	275	\$19,409.00
S59-3400HTU	HL2X2 with High Range Thermostat, Thermometer on Combined Outlet, and Mounted to Unit-Strut	3"	3"	10.0-384.0	275	\$19,409.00

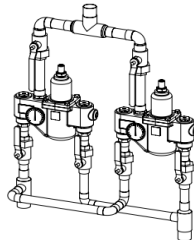

S59-3260



List Price

Effective Date February 1, 2024

Navigator High-Low Recirculation Station

THERMOSTATIC MIXING VALVES		
Model No.	Description	List Price
NRS-4	Navigator Recirculation Station with HL45 (S59-3045)	\$12,561.00
NRS-8	Navigator Recirculation Station with HL80 (S59-3080)	\$14,652.00
NRS-13	Navigator Recirculation Station with HL130 (S59-3130)	\$16,941.00
NRS-20	Navigator Recirculation Station with HL200 (S59-3200)	\$19,358.00
STANDARD SELECTIONS		
Add price for appropriate selection to thermostatic valve price above		
Recirculation Pump		
RP2	Bell & Gossett NBF-9U	\$1,264.00
RP3	Bell & Gossett PL-30B	\$1,944.00
RP4	Bell & Gossett PL-36B	\$2,196.00
RP5	Bell & Gossett PL-55B	\$3,024.00
RP6	Taco 008-SF6-IFC	\$1,796.00
RP7	Taco 009-SF5-IFC	\$2,208.00
RP8	Taco 0013-SF3-IFC	\$2,592.00
RP	Other Pump (Please Provide Manufacturer and Model #)	Contact Bradley for Pricing
Return Line		
R1	3/4" Return Line	N/C
R2	1" Return Line	\$783.00
R3	1-1/4" Return Line	\$1,407.00
R4	1-1/2" Return Line	\$1,899.00
R5	2" Return Line	\$2,465.00
OPTIONAL SELECTIONS		
Add price for optional selection to thermostatic valve price above		
Aquastat		
AQ	Aquastat	\$814.00
0	None	N/C
Thermostat		
H	High Range Thermostat	N/C
0	None	N/C

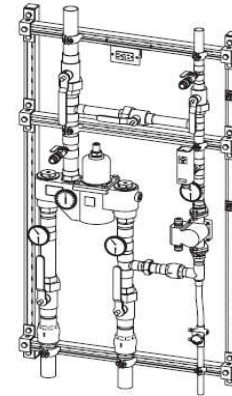

Non-Cancelable, Non-Returnable



List Price

Effective Date February 1, 2024

Navigator Standard Thermostatic Mixing Valves

THERMOSTATIC MIXING VALVES						
Model No.	Description	Inlet Size	Outlet Size	GPM	Ship Wt. (lbs)	List Price
S59-2025	TMV25 Thermostatic Mixing Valve	3/4"	3/4"	2.0-25.0	15	\$1,397.00
S59-2045	TMV45 Thermostatic Mixing Valve	3/4"	1"	5.0-47.0	18	\$1,556.00
S59-2080	TMV80 Thermostatic Mixing Valve	1"	1 1/4"	8.0-77.0	25	\$1,873.00
S59-2130	TMV130 Thermostatic Mixing Valve	1 1/4"	1 1/2"	13.0-126.0	40	\$2,460.00
S59-2200	TMV200 Thermostatic Mixing Valve	2"	2"	20.0-192.0	50	\$3,310.00

OPTIONAL SELECTIONS								
Add price to Thermostatic Mixing Valve Price Above						Sample: <u>TMV45 - I</u>		
Model No. Option Code	Description	Rough Brass R	Chrome Plated C	Standard- Range Thermostat S	Low-Range Thermostat L	High-Range Thermostat H	Thermometer T	Bracket B
S59-2025	TMV25 Thermostatic Mixing Valve	N/C	\$271.00	N/C	N/C	N/C	\$196.00	\$65.00
S59-2045	TMV45 Thermostatic Mixing Valve	N/C	\$271.00	N/C	N/C	N/C	\$196.00	\$65.00
S59-2080	TMV80 Thermostatic Mixing Valve	N/C	\$271.00	N/C	N/C	N/C	\$196.00	\$65.00
S59-2130	TMV130 Thermostatic Mixing Valve	N/C	\$290.00	N/C	N/C	N/C	\$196.00	\$70.00
S59-2200	TMV200 Thermostatic Mixing Valve	N/C	\$290.00	N/C	N/C	N/C	\$196.00	\$83.00

* For cabinets, piped assemblies, and window options see the following page

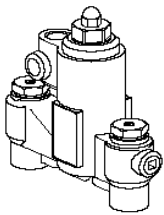

S59-2025

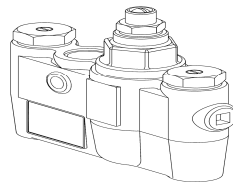

S59-2045

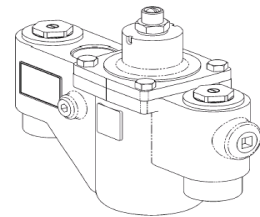

S59-2130



List Price

Effective Date February 1, 2024

Navigator Standard Thermostatic Mixing Valves

CABINETS, PIPED ASSEMBLY, AND WINDOW OPTIONS

Add price for appropriate option to thermostatic valve price

Cabinet only option does not include valve or piped assembly

Must specify cabinet option code and piping option code with order.

Cabinet prices include price for select pipe assembly

Sample: CAB-TMV45

Sample: TMV45 - P - RS

Valve	Option	Description	Ship Wt. (lbs)	Cabinet Only	Inlet & Outlet Shut Off Valves	Outlet Shut Off Valve Only
				CAB-TMV	P	N
TMV25 CAB-TMV25	P or N	P or N Piped Assembly	5	---	\$669.00	\$413.00
	SS	Surface Mount Stainless Steel Cabinet w/ Piping	5	\$1,372.00	\$2,102.00	\$1,839.00
	RS	Recessed Stainless Steel Cabinet w/ Piping	5	\$1,467.00	\$2,200.00	\$1,936.00
	SE	Surface Mount White Enamel Cabinet w/ Piping	5	\$1,372.00	\$2,102.00	\$1,839.00
	RE	Recessed White Enamel Cabinet w/ Piping	5	\$1,467.00	\$2,200.00	\$1,936.00
TMV45 CAB-TMV45	P or N	P or N Piped Assembly	5	---	\$757.00	\$421.00
	SS	Surface Mount Stainless Steel Cabinet w/ Piping	10	\$1,397.00	\$2,219.00	\$1,872.00
	RS	Recessed Stainless Steel Cabinet w/ Piping	10	\$1,477.00	\$2,302.00	\$1,955.00
	SE	Surface Mount White Enamel Cabinet w/ Piping	10	\$1,397.00	\$2,219.00	\$1,872.00
	RE	Recessed White Enamel Cabinet w/ Piping	10	\$1,477.00	\$2,302.00	\$1,955.00
TMV80 CAB-TMV80	P or N	P or N Piped Assembly	5	---	\$989.00	\$498.00
	SS	Surface Mount Stainless Steel Cabinet w/ Piping	10	\$1,451.00	\$2,514.00	\$2,008.00
	RS	Recessed Stainless Steel Cabinet w/ Piping	10	\$1,593.00	\$2,660.00	\$2,154.00
	SE	Surface Mount White Enamel Cabinet w/ Piping	10	\$1,451.00	\$2,514.00	\$2,008.00
	RE	Recessed White Enamel Cabinet w/ Piping	10	\$1,593.00	\$2,660.00	\$2,154.00
TMV130 CAB-TMV130	P or N	P or N Piped Assembly	10	---	\$1,273.00	\$637.00
	SS	Surface Mount Stainless Steel Cabinet w/ Piping	25	\$1,464.00	\$2,818.00	\$2,164.00
	RS	Recessed Stainless Steel Cabinet w/ Piping	25	\$1,681.00	\$3,042.00	\$2,388.00
	SE	Surface Mount White Enamel Cabinet w/ Piping	25	\$1,464.00	\$2,818.00	\$2,164.00
	RE	Recessed White Enamel Cabinet w/ Piping	25	\$1,681.00	\$3,042.00	\$2,388.00
TMV200 CAB-TMV200	P or N	P or N Piped Assembly (chrome plating not available)	10	---	\$1,589.00	\$794.00
	SS	Surface Mount Stainless Steel Cabinet w/ Piping	25	\$1,535.00	\$3,217.00	\$2,399.00
	RS	Recessed Stainless Steel Cabinet w/ Piping	25	\$1,699.00	\$3,386.00	\$2,567.00
	SE	Surface Mount White Enamel Cabinet w/ Piping	25	\$1,535.00	\$3,217.00	\$2,399.00
	RE	Recessed White Enamel Cabinet w/ Piping	25	\$1,699.00	\$3,386.00	\$2,567.00
	W	Plexiglass Window in Door		\$246.00	\$246.00	\$246.00

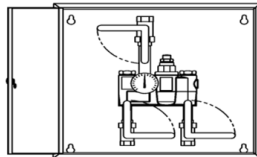

TMV45-T-P-



Navigator Point-Of-Use Thermostatic Mixing Valves

THERMOSTATIC MIXING VALVE						
Model No.	Description	Inlet Size	Outlet Size	GPM	Ship Wt. (lbs)	List Price
S59-2007	Thermostatic Valve - Sink/Faucet	1/2"	1/2"	0.5 to 8.0	8	\$471.00
S59-2007C	Thermostatic Valve Chrome Plated - Sink/Faucet	1/2"	1/2"	0.5 to 8.0	8	\$670.00
S59-2007T	Thermostatic Valve with Dial Thermometer - Sink/Faucet	1/2"	1/2"	0.5 to 8.0	8	\$718.00

Contact Bradley for cabinet options

*The S59-2005 Thermostatic Shower Valve Is Located On The 1C Page Of The Individual Showers Price Book, Model # 1C-TMV

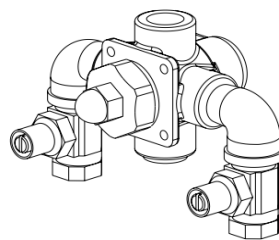

S59-2007

Navigator Dual Outlet Thermostatic Mixing Valves

THERMOSTATIC MIXING VALVE							
Model No.	Description	Inlet Size	Outlet Size	Faucet GPM	Eyewash GPM	Ship Wt. (lbs)	List Price
S19-2010	Thermostatic Valve - Faucet/Eyewash	1/2"	1/2"	0.2 to 4.0	1.5 to 8.0	5	\$1,150.00
S19-2010C	Thermostatic Valve Chrome Plated - Faucet/Eyewash	1/2"	1/2"	0.2 to 4.0	1.5 to 8.0	5	\$1,372.00

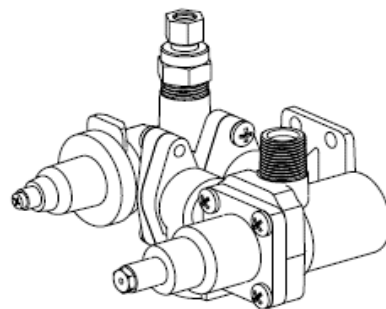

S19-2010



TEL: 1-800-BRADLEY FAX: 262-251-5817
 Web Site: www.bradleycorp.com

List Price

Effective Date February 1, 2024

Navigator Point-Of-Use Thermostatic Mixing Valve

THERMOSTATIC MIXING VALVES						
Model No.	Description	Inlet Size	Outlet Size	GPM	Ship Wt. (lbs)	List Price
S59-4000	1/2" Lead Free Thermostatic Mixing Valve	1/2"	1/2"	0.35 to 5.5	1	\$145.00
S59-4000A	3/8" Compression Lead Free Thermostatic Mixing Valve	3/8"	3/8"	0.35 to 5.5	1	\$161.00
S59-4000BY	3/8" Compression Lead Free Thermostatic Mixing Valve with By-Pass	3/8"	3/8"	0.35 to 5.5	1	\$184.00
S59-4007	Navigator Thermostatic Mixing Valve with 1/2" Male NPT Connection	1/2"	1/2"	0.5 to 8.5	1.35	\$242.00
S59-4016D	Navigator Thermostatic Mixing Valve with 1/2" NPT sweat connections	1/2"	1/2"	0.5 to 15.0	2	\$256.00
S59-4016N	Navigator Thermostatic Mixing Valve with 3/4" NPT connections	3/4"	3/4"	0.5 to 15.0	2	\$276.00
S59-4016S	Navigator Thermostatic Mixing Valve with 3/4" sweat connections	3/4"	3/4"	0.5 to 15.0	2	\$276.00
S59-4016X	Navigator Thermostatic Mixing Valve with 1/2" PEX connections	1/2"	1/2"	0.5 to 15.0	2	\$256.00
S59-4016EX	Navigator Thermostatic Mixing Valve with 1/2" Expansion connections	1/2"	1/2"	0.5 to 15.0	2	\$256.00
S59-4016Y	Navigator Thermostatic Mixing Valve with 3/4" PEX connections	3/4"	3/4"	0.5 to 15.0	2	\$276.00
S59-4016EY	Navigator Thermostatic Mixing Valve with 3/4" Expansion connections	3/4"	3/4"	0.5 to 15.0	2	\$276.00
S45-2456	Optional Mounting Bracket (for use with S59-4000 and S59-4016 series)	-	-	-	-	\$30.00
S45-2976	Optional Mounting Bracket (for use with S59-4007 valve only)	-	-	-	-	\$30.00

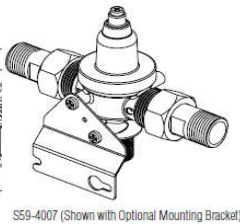
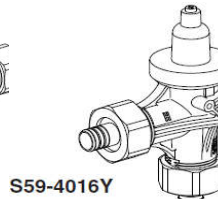
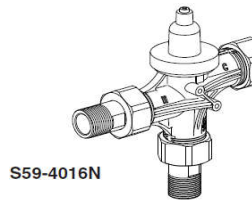
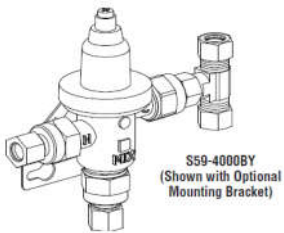
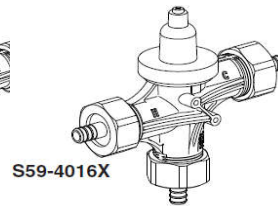
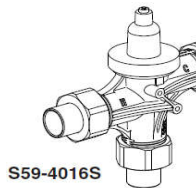
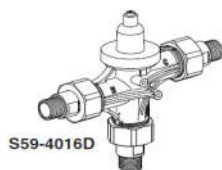
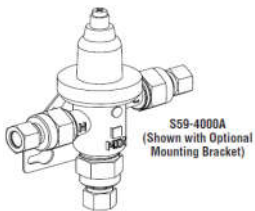



Navigator Tepid Water System

Emergency Tepid Water Tank and TMV						
Model No.	Description	Inlet Size	Outlet Size	GPM	Ship Wt. (lbs)	List Price
S19-T120A	Tepid Water System, 240V Single Phase Power	1 1/4"	1 1/4"	3.0-65.0	350	\$15,714.00
S19-T120B	Tepid Water System, 208V Single Phase Power	1 1/4"	1 1/4"	3.0-65.0	350	\$15,714.00
S19-T120C	Tepid Water System, 277V Single Phase Power	1 1/4"	1 1/4"	3.0-65.0	350	\$15,714.00
S19-T120D	Tepid Water System, 480V Single Phase Power	1 1/4"	1 1/4"	3.0-65.0	350	\$15,714.00
S19-T120E	Tepid Water System, 240V Three Phase Power	1 1/4"	1 1/4"	3.0-65.0	350	\$15,714.00
S19-T120F	Tepid Water System, 208V Three Phase Power	1 1/4"	1 1/4"	3.0-65.0	350	\$15,714.00
S19-T120G	Tepid Water System, 2277V Three Phase Power	1 1/4"	1 1/4"	3.0-65.0	350	\$15,714.00
S19-T120H	Tepid Water System, 480V Three Phase Power	1 1/4"	1 1/4"	3.0-65.0	350	\$15,714.00



S19-T120A