



TEL: 800.BRADLEY  
FAX: 262.251.5817  
bradleycorp.com

## Emergency Fixtures List Price Book 0224EFP

Halo Eye and Eye/Face Wash	3-4
Halo Combination Shower Eye and Eye/Face Wash	5
Halo Pre-Configured	6-8
Classic Pre-Configured, Value Based Pre-Configured	9
Drench Showers	10-11
Recessed-Mounted Fixtures	12
Faucet-Mount, Unmounted, Deck-Mounted Eye and Eye/Face Wash	13
Halo Heat Trace Combination Shower and Eye/Face Wash	14-15
Hand-Held & Recoiling Drench Hoses	16
Portable Eyewash Units	17
Emergency Thermostatic Mixing Valves	18
Emergency Signaling Systems	19-22
Accessories	23
Replacement Parts	24-29



**PRICES**

This price list applies from its effective date and all prior corresponding price lists are canceled. Prices are subject to change without notice. Items may be changed or discontinued without notice and without incurring obligation. For job quotations, please contact your Bradley Sales Representative in your area.

**CREDIT TERMS**

Open Account Terms are Net 30 days from date of invoice. Past due accounts may be subject to a service charge. Settlement of past due invoices may be required before additional shipments will be made. Cash in advance may be required when open accounts are not approved. Credit Department Phone 1-800-BRADLEY, FAX (262) 251-7747.

**MINIMUM ORDERS**

Orders under \$100.00 net will incur a \$15.00 service charge.

**RETURN MERCHANDISE  
AUTHORIZATION AND  
CANCELLATIONS**

Bradley shall provide Return Materials Authorization (RMA) to original purchaser for all authorized returns. It shall be the responsibility of the original purchaser to obtain written RMA authorization to return merchandise for credit. Materials must be in the original packaging and in resaleable as new condition. Items returned without RMA information provided will be refused and returned for delivery back to sender at sender's expense freight collect. A minimum of 25% handling and restocking charge (or \$50.00, whichever is greater) is required on all returns. Standard fixtures will be considered for return. Other custom-fabricated modified fixtures and special fixture items will not be considered for return, and are non-cancelable when entered by Bradley.

Please refer to our policy at <http://www.bradleycorp.com/customerservice/rma> for details.

**SHIPMENTS AND CLAIMS**

Transit damage should be noted on the freight bill before signing for receipt of material. Bradley should be notified by FAX immediately. Bradley will then file the claim with the contracted carrier as a service to the customer.

Claims for shipment shortages must be FAXed within two (2) weeks of invoice date to Bradley with documentation and are subject to factory verification.

**TECHNICAL ASSISTANCE**

Your Bradley Sales Representative can provide technical or promotional information on Bradley Products.

**FREIGHT CLASSIFICATION**

Washfountains 77-1/2	Emergency Fixtures 70
Showers 70	Patient Care 92-1/2

**WARRANTY**

Product warranties may be found under 'Product Information' on our website at [www.bradleycorp.com](http://www.bradleycorp.com).



List Price

Effective Date February 1, 2024

## S19214 Series Halo Pedestal Mount Eye and Eye/Face Wash

### MODELS

Model No.	Description	Price
S19214	Pedestal-Mount Halo™ Eyewash or Eye/Face Wash	
<b>Options (Must choose one from each section)</b>		
<b>Configuration</b>		
B	24" Drain Height	\$564.00
0	6" Drain Height, Standard	\$495.00

Pipe Material		
A	NPT, Yellow BradTect Galv. Steel	N/C
B	NPT, All 304 Stainless Steel	\$973.00
C	NPT, All 316 Stainless Steel*	\$1,497.00
D	NPT, Chrome-Plated	\$1,855.00
F	BSP, YellowBradTect Galvanized Steel ‡	N/C
G	BSP, All 304 Stainless Steel ‡	\$973.00
H	BSP, All 316 Stainless Steel ‡	\$1,497.00
J	BSP, Chrome-Plated ‡	\$1,855.00

‡ Not available in the U.S.

Ball Valve		
1	Stay-Open Eyewash Valve Chrome-Plated Brass	N/C
2	Stay-Open Eyewash Valve 316 SS	\$38.00

Eyewash - Eye/Face Wash		
A	Halo Eye Wash	N/C
B	Halo Eye/Face Wash	\$100.00
D	Halo Eye Wash, 304 SS Yoke	\$78.00
E	Halo Eye/Face Wash, 304 SS Yoke	\$183.00
F	304 SS Halo, Eye/Face Wash, 304 SS Yoke**	\$241.00
G	Halo Eye Wash, 316 SS Yoke	\$108.00
H	Halo Eye/Face Wash, 316 SS Yoke	\$217.00
J	316 SS Halo Eye/Face Wash, 316 SS Yoke**	\$276.00

\*\* Must select SS pipe and ball valve when SS eye/face wash is required

Bowl and Dust Cover		
A	Plastic Bowl, No Dust Cover	N/C
B	Plastic Bowl, Plastic Dust Cover	\$165.00
D	304 SS Bowl, No Dust Cover	\$137.00
E	304 SS Bowl, 304 SS Dust Cover	\$461.00
F	304 SS Bowl, Plastic Dust Cover	\$357.00
G	316 SS Bowl, No Dust Cover	\$282.00
H	316 SS Bowl, 316 SS Dust Cover	\$972.00
J	316 SS Bowl, Plastic Dust Cover	\$453.00
0	No Bowl or Dust Cover	(\$45.00)

Activation		
A	300 SS Handle	N/C
B	316 SS Handle	\$80.00
C	300 Series SS Handle With Foot Pedal*	\$115.00
D	300 Series SS Handle With 316 SS Foot Pedal*	\$523.00
E	316 SS Handle With 316 SS Foot Pedal*	\$665.00

\* Not available with barrier-free configurations or with chrome plated pipe

Drench Hose and Backflow Prevention		
A	Spray Kit w/Vacuum Breaker	\$615.00
B	Spray Kit w/Backflow Preventer-N9	\$597.00
C	Spray Kit w/Backflow Preventer-9D	\$657.00
D	Spray Kit w/o Backflow Preventer	\$368.00
0	None	N/C

Freeze/Scald Protection		
N	Anti-Freeze Valve	\$746.00
P	Anti-Scald Valve	\$746.00
R	Anti-Freeze & Anti-Scald Valve	\$1,488.00
Z	Anti-Freeze & Anti-Scald Valve Ready	\$72.00
0	None	N/C

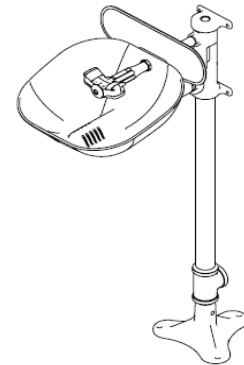



List Price

Effective Date February 1, 2024

# S19224 Series Halo Wall Mount Eye and Eye/Face Wash

## MODELS

Model No.	Description	Price
S19224	Wall-Mount Halo™ Eyewash or Eye/Face Wash	

## Options (Must choose one from each section)

Configuration	Description	Price
0	Standard	\$375.00

Pipe Material	Description	Price
A	NPT, Yellow BradTect Galv. Steel	N/C
B	NPT, All 304 Stainless Steel	\$835.00
C	NPT, All 316 Stainless Steel	\$1,056.00
D	NPT, Chrome-Plated	\$1,567.00
F	BSP, YellowBradTect Galvanized Steel ‡	N/C
G	BSP, All 304 Stainless Steel ‡	\$835.00
H	BSP, All 316 Stainless Steel ‡	\$1,056.00
J	BSP, Chrome-Plated ‡	\$1,567.00

‡ Not available in the U.S.

Ball Valve	Description	Price
1	Stay-Open Eyewash Valve Chrome-Plated Brass	N/C
2	Stay-Open Eyewash Valve 316 SS	\$38.00

Eyewash - Eye / Face Wash	Description	Price
A	Halo Eye Wash	N/C
B	Halo Eye/Face Wash	\$100.00
D	Halo Eye Wash, 304 SS Yoke	\$78.00
E	Halo Eye/Face Wash, 304 SS Yoke	\$183.00
F	304 SS Halo, Eye/Face Wash, 304 SS Yoke**	\$241.00
G	Halo Eye Wash, 316 SS Yoke	\$108.00
H	Halo Eye/Face Wash, 316 SS Yoke	\$217.00
J	316 SS Halo Eye/Face Wash, 316 SS Yoke**	\$276.00

\*\* Must select SS pipe and ball valve when SS eye/face wash is required

Bowl and Dust Cover	Description	Price
A	Plastic Bowl, No Dust Cover	N/C
B	Plastic Bowl, Plastic Dust Cover	\$165.00
D	304 SS Bowl, No Dust Cover	\$137.00
E	304 SS Bowl, 304 SS Dust Cover	\$461.00
F	304 SS Bowl, Plastic Dust Cover	\$357.00
G	316 SS Bowl, No Dust Cover	\$282.00
H	316 SS Bowl, 316 SS Dust Cover	\$972.00
J	316 SS Bowl, Plastic Dust Cover	\$453.00
0	No Bowl or Dust Cover	(\$45.00)

Activation	Description	Price
A	300 SS Handle	N/C
B	316 SS Handle	\$80.00
D	300 Series SS Handle With SS Foot Pedal*	\$523.00

\*Not available with barrier-free configurations

Waste	Description	Price
A	Tailpiece	N/C
D	P-Trap	\$53.00
0	None	N/C

Drench Hose and Backflow Prevention	Description	Price
A	Spray Kit w/Vacuum Breaker	\$615.00
B	Spray Kit w/Backflow Precenter-N9	\$597.00
C	Spray Kit w/Backflow Preventer-9D	\$657.00
D	Spray Kit w/o Backflow Preventer	\$368.00
0	None	N/C

Freeze / Scald Protection	Description	Price
N	Anti-Freeze Valve	\$746.00
P	Anti-Scald Valve	\$746.00
R	Anti-Freeze & Anti-Scald Valves	\$1,488.00
Z	Anti-Freeze & Anti-Scald Valve Ready	\$72.00
0	None	N/C

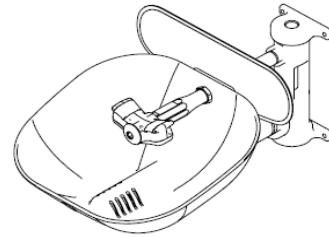



List Price

Effective Date February 1, 2024

## S19314 Series Halo Combination Units

MODELS		
Model No.	Description	Price
S19314	Combination Drench Shower and Halo™ Eyewash or Eye/Face Wash	
Options (Must choose one from each section)		
Configuration		
A	6" Drain Height, Barrier-Free	\$1,329.00
B	24" Drain Height	\$1,330.00
C	24" Drain Height, Barrier-Free	\$1,446.00
0	6" Drain Height, Standard	\$1,213.00
Pipe Material		
A	NPT, Yellow BradTect Galvanized Steel	N/C
B	NPT, All 304 Stainless Steel	\$2,104.00
C	NPT, All 316 Stainless Steel*	\$3,041.00
D	NPT, Chrome-Plated Brass	\$4,027.00
F	BSP, Yellow BradTect Galvanized Steel ‡	N/C
G	BSP, All 304 Stainless Steel ‡	\$2,104.00
H	BSP, All 316 Stainless Steel ‡	\$3,041.00
J	BSP, Chrome-Plated ‡	\$3,132.00
‡ Not available in the U.S.		
Ball Valve		
1	Stay-Open Shower & Eyewash Chrome Plated Brass	N/C
2	Stay-Open Shower & Eyewash 316 SS	\$38.00
3	Self-Closing Shower, Stay-Open Eyewash†	\$78.00
†Self-closing valves are not ANSI/ISEA Z358.1 compliant		
Showerhead		
A	Plastic Showerhead	N/C
B	Plastic Showerhead with Plastic Shroud	\$57.00
C	Plastic Showerhead with Stainless steel Shroud	\$118.00
D	304 SS High Performance Showerhead	\$168.00
E	316 SS High Performance Showerhead	\$230.00
Eyewash - Eye / Face Wash		
A	Halo Eye Wash	N/C
B	Halo Eye/Face Wash	\$100.00
D	Halo Eye Wash, 304 SS Yoke	\$78.00
E	Halo Eye/Face Wash, 304 SS Yoke	\$183.00
F	304 SS Halo, Eye/Face Wash, 304 SS Yoke**	\$241.00
G	Halo Eye Wash, 316 SS Yoke	\$108.00
H	Halo Eye/Face Wash, 316 SS Yoke	\$217.00
J	316 SS Halo Eye/Face Wash, 316 SS Yoke**	\$276.00
** Must select SS pipe and ball valve when SS eye/face wash is required		
Bowl and Dust Cover		
A	Plastic Bowl, No Dust Cover	N/C
B	Plastic Bowl, Plastic Dust Cover	\$165.00
D	304 SS Bowl, No Dust Cover	\$137.00
E	304 SS Bowl, 304 SS Dust Cover	\$461.00
F	304 SS Bowl, Plastic Dust Cover	\$357.00
G	316 SS Bowl, No Dust Cover	\$282.00
H	316 SS Bowl, 316 SS Dust Cover	\$972.00
J	316 SS Bowl, Plastic Dust Cover	\$453.00
0	No Bowl or Dust Cover	(\$45.00)
Activation		
A	300 SS Handle	N/C
B	316 SS Handle	\$80.00
C	300 Series SS Handle With Foot Pedal*	\$115.00
D	300 Series SS Handle With 316 SS Foot Pedal*	\$523.00
E	316 SS Handle With 316 SS Foot Pedal*	\$665.00
*Not available with barrier-free configurations or with chrome plated pipe		
Drench Hose and Backflow Prevention		
A	Spray Kit w/Vacuum Breaker	\$615.00
B	Spray Kit w/Backflow Preventer-N9	\$597.00
C	Spray Kit w/Backflow Preventer-9D	\$657.00
D	Spray Kit w/o Backflow Preventer	\$368.00
Z	Drench Hose Ready	\$72.00
0	None	N/C
Freeze / Scald Protection		
N	Anti-Freeze Valve	\$746.00
P	Anti-Scald Valve	\$746.00
R	Anti-Freeze & Anti-Scald Valves	\$1,488.00
Z	Anti-Freeze & Anti-Scald Valve Ready	\$72.00
0	None	N/C

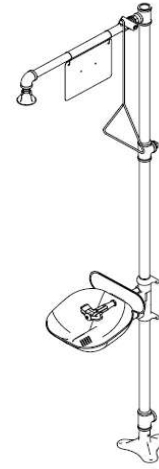



List Price

Effective Date February 1, 2024

## Halo Preconfigured Units

MODELS			
Model No.	Description	Ship Wt. (lbs)	Price
<b>S19214 Series Halo Pedestal Mount Eye and Eye/Face Wash</b>			
S19214EW	Halo Eyewash, plastic bowl	19.7	\$495.00
S19214PDC	Halo Eyewash, plastic bowl w/ dust cover	20.2	\$655.00
S19214B	Halo Eyewash, stainless steel bowl	20.9	\$634.00
S19214DC	Halo Eyewash, stainless steel bowl & hinged dust cover	22.6	\$956.00
S19214FW	Halo Eye/face wash, plastic bowl	20.1	\$596.00
S19214PDCFW	Halo Eye/face wash, plastic bowl w/ dust cover	20.3	\$757.00
S19214Y	Halo Eye/face wash, stainless steel bowl	20.2	\$734.00
S19214P	Halo Eye/face wash, stainless steel bowl w/ hose spray	23.7	\$1,091.00
S19214YF	Halo Eye/face wash, stainless steel bowl, hand/foot operated	22.2	\$847.00
S19214DCFW	Halo Eye/face wash, stainless steel bowl & hinged dust cover	23.6	\$1,058.00
S19214BSS	Halo Stainless steel eye/face wash & bowl	23.5	\$1,888.00
S19214SC	Halo Stainless steel eye/face wash, bowl & hinged dust cover	25.9	\$2,211.00
S19214SS	Halo Stainless steel eye/face wash, bowl, hand/foot operated	24.5	\$2,394.00
<b>S19224 Series Halo Wall Mounted eye and Eye/Face Wash</b>			
S19224EW	Halo Eyewash, plastic bowl	13.0	\$375.00
S19224PDC	Halo Eyewash, plastic bowl w/ dust cover	13.9	\$535.00
S19224B	Halo Eyewash, stainless steel bowl	14.1	\$512.00
S19224DC	Halo Eyewash, stainless steel bowl & hinged dust cover	16.3	\$836.00
S19224FW	Halo Eye/face wash, plastic bowl	13.2	\$476.00
S19224PDCFW	Halo Eye/face wash, plastic bowl w/ dust cover	14.1	\$637.00
S19224T	Halo Eye/face wash, stainless steel bowl	14.3	\$613.00
S19224PT	Halo Eyewash, plastic bowl, p-trap	14.0	\$428.00
S19224BPT	Halo Eyewash, stainless steel bowl, p-trap	15.1	\$564.00
S19224DCPT	Halo Eyewash, stainless steel bowl & hinged dust cover, p-trap	17.8	\$888.00
S19224FWPT	Halo Eye/face wash, plastic bowl, p-trap	14.3	\$528.00
S19224P	Halo Eye/face wash, stainless steel bowl w/ hose spray, tailpiece	18.4	\$970.00
S19224TPT	Halo Eye/face wash, stainless steel bowl, p-trap	15.3	\$666.00
S19224Y	Halo Eye/face wash, stainless steel bowl, hand/foot operated, tailpiece	16.2	\$1,121.00
S19224DCRPT	Halo Eye/face wash, stainless steel bowl & hinged dust cover, p-trap	11.7	\$989.00
S19224DCFW	Halo Eye/face wash, stainless steel bowl & hinged dust cover	16.5	\$937.00
S19224SC	Halo Stainless steel eye/face wash, bowl & hinged dust cover	18.8	\$1,951.00
S19224SS	Halo Stainless steel eye/face wash & bowl	16.6	\$1,627.00
<b>S19314 Series Halo Combination Units</b>			
S19314BF	Halo Eye/face wash; barrier-free, plastic showerhead, stainless steel bowl,	41.0	\$1,568.00
S19314P	Halo Eyewash; plastic showerhead & bowl w/ hose spray	42.1	\$1,571.00
S19314EW	Halo Eyewash; plastic showerhead & bowl	38.9	\$1,213.00
S19314PDC	Halo Eyewash; plastic showerhead & bowl w/ dust cover	39.9	\$1,374.00
S19314SB	Halo Eyewash; plastic showerhead, stainless steel bowl	40.2	\$1,350.00
S19314DC	Halo Eyewash; plastic showerhead, stainless steel bowl & hinged dust cover,	43.0	\$1,675.00
S19314FW	Halo Eye/face wash; plastic showerhead & bowl	39.4	\$1,314.00
S19314PDCFW	Halo Eye/face wash; plastic showerhead & bowl w/ dust cover	40.1	\$1,474.00
S19314SBFW	Halo Eye/face wash; plastic showerhead, stainless steel bowl,	40.8	\$1,452.00
S19314AC	Halo Eye/face wash; plastic showerhead, stainless steel bowl, hand/foot operated eyewash	41.9	\$1,564.00
S19314DCFW	Halo Eye/face wash; plastic showerhead, stainless steel bowl & hinged dust cover,	44.0	\$1,776.00
S19314F	Halo Eyewash; plastic showerhead w/ stainless steel shroud & bowl	42.5	\$1,468.00
S19314BFPB	Halo Eye/face wash; barrier-free, plastic showerhead & bowl	42.0	\$1,430.00
S19314DCBF	Halo Eye/face wash; barrier-free, plastic showerhead, stainless steel bowl w/ dust cover	43.6	\$1,891.00
S19314LL	Halo Eyewash; plastic showerhead, stainless steel bowl, hand/foot activated	41.3	\$1,463.00
S19314GG	Halo Eye/face wash; plastic showerhead, no bowl	36.9	\$1,260.00
S19314TT	Halo Eye/face wash; plastic showerhead w/ stainless steel shroud & bowl	41.7	\$1,568.00
S19314SPR	Halo Eye/face wash; stainless steel showerhead & bowl, hand/foot operated eyewash	43.3	\$1,732.00
S19314UU	Halo Eyewash; plastic showerhead w/ stainless steel shroud & bowl, hand/foot operated eyewash	43.0	\$1,578.00
S19314BFSS	Halo Stainless steel eye/face wash & showerhead, barrier-free	43.3	\$4,019.00
S19314FSS	Halo Stainless steel eye/face wash & showerhead	42.5	\$3,906.00
S19314SC	Halo Stainless steel eye/face wash, bowl, hinged dust cover & showerhead	46.3	\$4,229.00
S19314SS	Halo Stainless steel eye/face wash, showerhead, hand/foot activated	45.6	\$4,411.00
S19314SS16	Halo 316 Stainless steel eye/face wash, showerhead, hand/foot activated	43.3	\$4,561.00

Prices subject to change without notice.  
Items may be changed or discontinued  
without notice and without incurring obligation.



List Price

Effective Date February 1, 2024

## European Models

### Halo Preconfigured British Standard Pipe Units

MODELS			
Model No.	Description	Ship Wt. (lbs)	Price
<b>S19214 Series Halo Pedestal Mount Eye and Eye/Face Wash</b>			
S19214EWZ	Halo Eyewash, plastic bowl	19.7	\$535.00
S19214PDCZ	Halo Eyewash, plastic bowl w/ dust cover	20.2	\$707.00
S19214BZ	Halo Eyewash, stainless steel bowl	20.9	\$683.00
S19214DCZ	Halo Eyewash, stainless steel bowl & hinged dust cover	22.6	\$1,033.00
S19214FWZ	Halo Eye/face wash, plastic bowl	20.1	\$644.00
S19214PDCFWZ	Halo Eye/face wash, plastic bowl w/ dust cover	20.3	\$818.00
S19214YZ	Halo Eye/face wash, stainless steel bowl	20.2	\$793.00
S19214PZ	Halo Eye/face wash, stainless steel bowl w/ hose spray	23.7	\$1,177.00
S19214YFZ	Halo Eye/face wash, stainless steel bowl, hand/foot operated	22.2	\$916.00
S19214DCFWZ	Halo Eye/face wash, stainless steel bowl & hinged dust cover	23.6	\$1,143.00
S19214BSSZ	Halo Stainless steel eye/face wash & bowl	23.5	\$2,037.00
S19214SCZ	Halo Stainless steel eye/face wash, bowl & hinged dust cover	25.9	\$2,389.00
S19214SSZ	Halo Stainless steel eye/face wash, bowl, hand/foot operated	24.5	\$2,586.00
<b>S19224 Series Halo Wall Mounted eye and Eye/Face Wash</b>			
S19224EWZ	Halo Eyewash, plastic bowl	13.0	\$407.00
S19224PDCZ	Halo Eyewash, plastic bowl w/ dust cover	13.9	\$578.00
S19224BZ	Halo Eyewash, stainless steel bowl	14.1	\$555.00
S19224DCZ	Halo Eyewash, stainless steel bowl & hinged dust cover	16.3	\$904.00
S19224FWZ	Halo Eye/face wash, plastic bowl	13.2	\$513.00
S19224PDCFWZ	Halo Eye/face wash, plastic bowl w/ dust cover	14.1	\$688.00
S19224TZ	Halo Eye/face wash, stainless steel bowl	14.3	\$661.00
S19224PTZ	Halo Eyewash, plastic bowl, p-trap	14.0	\$462.00
S19224BPTZ	Halo Eyewash, stainless steel bowl, p-trap	15.1	\$612.00
S19224DCPTZ	Halo Eyewash, stainless steel bowl & hinged dust cover, p-trap	17.8	\$962.00
S19224FWPTZ	Halo Eye/face wash, plastic bowl, p-trap	14.3	\$571.00
S19224PZ	Halo Eye/face wash, stainless steel bowl w/ hose spray, tailpiece	18.4	\$1,050.00
S19224TPTZ	Halo Eye/face wash, stainless steel bowl, p-trap	15.3	\$721.00
S19224YZ	Halo Eye/face wash, stainless steel bowl, hand/foot operated, tailpiece	16.2	\$1,212.00
S19224DCRPTZ	Halo Eye/face wash, stainless steel bowl & hinged dust cover, p-trap	11.7	\$1,069.00
S19224DCFWZ	Halo Eye/face wash, stainless steel bowl & hinged dust cover	16.5	\$1,015.00
S19224SCZ	Halo Stainless steel eye/face wash, bowl & hinged dust cover	18.8	\$2,108.00
S19224SSZ	Halo Stainless steel eye/face wash and bowl	16.6	\$1,758.00
<b>S19314 Series Halo Combination Units</b>			
S19314BFZ	Halo Eye/face wash; barrier-free, stainless steel bowl, plastic showerhead	41.0	\$1,692.00
S19314PZ	Halo Eyewash; plastic showerhead & bowl w/hose spray	42.1	\$1,697.00
S19314EWZ	Halo Eyewash; plastic showerhead & bowl	38.9	\$1,310.00
S19314PDCZ	Halo Eyewash; plastic showerhead & bowl w/ dust cover	39.9	\$1,484.00
S19314SBZ	Halo Eyewash; plastic showerhead, stainless steel bowl	40.2	\$1,461.00
S19314DCZ	Halo Eyewash; stainless steel bowl & hinged dust cover, plastic showerhead	43.0	\$1,809.00
S19314FWZ	Halo Eye/face wash; plastic bowl & showerhead	39.4	\$1,422.00
S19314PDCFWZ	Halo Eye/face wash; plastic showerhead & bowl w/ dust cover	40.1	\$1,592.00
S19314SBFWZ	Halo Eye/face wash; stainless steel bowl, plastic showerhead	40.8	\$1,571.00
S19314ACZ	Halo Eye/face wash; stainless steel bowl, plastic showerhead, hand/foot operated	41.9	\$1,690.00
S19314DCFWZ	Halo Eye/face wash; stainless steel bowl & hinged dust cover, plastic showerhead	44.0	\$1,918.00
S19314FZ	Halo Eyewash; plastic showerhead w/ stainless steel shroud & bowl	42.5	\$1,584.00
S19314BFPBZ	Halo Eye/face wash; barrier-free, plastic showerhead & bowl	42.0	\$1,542.00
S19314DCBFZ	Halo Eye/face wash; barrier-free, plastic showerhead, stainless steel bowl w/ dust cover	43.6	\$2,041.00
S19314LLZ	Halo Eyewash; plastic showerhead, stainless steel bowl, hand/foot activated	41.3	\$1,581.00
S19314GGZ	Halo Eye/face wash; plastic showerhead, no bowl	36.9	\$1,360.00
S19314TTZ	Halo Eye/face wash; plastic showerhead w/ stainless steel shroud & bowl	41.7	\$1,695.00
S19314SPRZ	Halo Eye/face wash; stainless steel showerhead & bowl, hand/foot operated eyewash	43.3	\$1,872.00
S19314UUZ	Halo Eyewash; plastic showerhead w/ stainless steel shroud & bowl, hand/foot operated eyewash	43.0	\$1,707.00
S19314BFSSZ	Halo Stainless steel eye/face wash & showerhead, barrier-free	43.3	\$4,339.00
S19314FSSZ	Halo Stainless steel eye/face wash & showerhead	42.5	\$4,217.00
S19314SCZ	Halo Stainless steel eye/face wash, bowl, hinged dust cover & showerhead	46.3	\$4,567.00
S19314SSZ	Halo Stainless steel eye/face wash, showerhead, hand/foot activated	45.6	\$4,767.00
S19314SS16Z	Halo 316 Stainless steel eye/face wash, showerhead, hand/foot activated	43.3	\$4,923.00

Note: All prices are shown in US dollars





List Price

Effective Date February 1, 2024

## European and Australian Models

### Halo Preconfigured BSPP Units AS 4775 & AS/NS 4020 Certified

MODELS			
Model No.	Description	Ship Wt. (lbs)	Price
<b>S19214 Series Halo Pedestal Mount Eye and Eye/Face Wash</b>			
S19214EWZS	Halo Eyewash, plastic bowl	19.7	\$1,592.00
S19214PDCZS	Halo Eyewash, plastic bowl w/ dust cover	20.2	\$1,747.00
S19214BZS	Halo Eyewash, stainless steel bowl	20.9	\$1,772.00
S19214DCZS	Halo Eyewash, stainless steel bowl & hinged dust cover	22.6	\$2,209.00
S19214FWZS	Halo Eye/face wash, plastic bowl	20.1	\$1,695.00
S19214PCFWZS	Halo Eye/face wash, plastic bowl w/ dust cover	20.3	\$1,848.00
S19214YZS	Halo Eye/face wash, stainless steel bowl	20.2	\$1,873.00
S19214YFZS	Halo Eye/face wash, stainless steel bowl, hand/foot operated	22.2	\$1,985.00
S19214DCFWZS	Halo Eye/face wash, stainless steel bowl & hinged dust cover	23.6	\$2,308.00
S19214BSSZ	Halo Stainless steel eye/face wash & bowl	23.5	\$2,037.00
S19214SCZ	Halo Stainless steel eye/face wash, bowl & hinged dust cover	25.9	\$2,389.00
S19214SSZ	Halo Stainless steel eye/face wash, bowl, hand/foot operated	24.5	\$2,586.00
<b>S19224 Series Halo Wall Mounted eye and Eye/Face Wash</b>			
S19224EWZS	Halo Eyewash, plastic bowl	13.0	\$1,338.00
S19224PDCZS	Halo Eyewash, plastic bowl w/ dust cover	13.9	\$1,491.00
S19224BZS	Halo Eyewash, stainless steel bowl	14.1	\$1,519.00
S19224DCZS	Halo Eyewash, stainless steel bowl & hinged dust cover	16.3	\$1,951.00
S19224FWZS	Halo Eye/face wash, plastic bowl	13.2	\$1,439.00
S19224PCFWZS	Halo Eye/face wash, plastic bowl w/ dust cover	14.1	\$1,589.00
S19224TZS	Halo Eye/face wash, stainless steel bowl	14.3	\$1,618.00
S19224PTZS	Halo Eyewash, plastic bowl, p-trap	14.0	\$1,391.00
S19224BPTZS	Halo Eyewash, stainless steel bowl, p-trap	15.1	\$1,571.00
S19224DCPTZS	Halo Eyewash, stainless steel bowl & hinged dust cover, p-trap	17.8	\$2,005.00
S19224FWPTZS	Halo Eye/face wash, plastic bowl, p-trap	14.3	\$1,491.00
S19224TPTZS	Halo Eye/face wash, stainless steel bowl, p-trap	15.3	\$1,670.00
S19224YZS	Halo Eye/face wash, stainless steel bowl, hand/foot operated, tailpiece	16.2	\$2,126.00
S19224DCRPTZS	Halo Eye/face wash, stainless steel bowl & hinged dust cover, p-trap	11.7	\$2,104.00
S19224DCFWZS	Halo Eye/face wash, stainless steel bowl & hinged dust cover	16.5	\$2,053.00
S19224SCZ	Halo Stainless steel eye/face wash, bowl & hinged dust cover	18.8	\$2,108.00
S19224SSZ	Halo Stainless steel eye/face wash and bowl	16.6	\$1,758.00
<b>S19314 Series Halo Combination Units</b>			
S19314BFZS	Halo Eye/face wash; barrier-free, stainless steel bowl, plastic showerhead	41.0	\$3,820.00
S19314EWZS	Halo Eyewash; plastic showerhead & bowl	38.9	\$3,467.00
S19314PDCZS	Halo Eyewash; plastic showerhead & bowl w/ dust cover	39.9	\$3,617.00
S19314SBZS	Halo Eyewash; plastic showerhead, stainless steel bowl	40.2	\$3,645.00
S19314DCZS	Halo Eyewash; stainless steel bowl & hinged dust cover, plastic showerhead	43	\$4,081.00
S19314FWZS	Halo Eye/face wash; plastic bowl & showerhead	39.4	\$3,566.00
S19314PCFWZS	Halo Eye/face wash; plastic showerhead & bowl w/ dust cover	40.1	\$3,718.00
S19314SBFWZS	Halo Eye/face wash; stainless steel bowl, plastic showerhead	40.8	\$3,746.00
S19314ACZS	Halo Eye/face wash; stainless steel bowl, plastic showerhead, hand/foot operated	41.9	\$3,856.00
S19314DCFWZS	Halo Eye/face wash; stainless steel bowl & hinged dust cover, plastic showerhead	44	\$4,180.00
S19314FZS	Halo Eyewash; plastic showerhead w/ stainless steel shroud & bowl	42.5	\$3,762.00
S19314BFPBZS	Halo Eye/face wash; barrier-free, plastic showerhead & bowl	42	\$3,643.00
S19314DCBFZS	Halo Eye/face wash; barrier-free, plastic showerhead, stainless steel bowl w/ dust cover	43.6	\$4,258.00
S19314LLZS	Halo Eyewash; plastic showerhead, stainless steel bowl, hand/foot activated	41.3	\$3,757.00
S19314GGZS	Halo Eye/face wash; plastic showerhead, no bowl	36.9	\$3,510.00
S19314TTZS	Halo Eye/face wash; plastic showerhead w/ stainless steel shroud & bowl	41.7	\$3,860.00
S19314SPRZS	Halo Eye/face wash; stainless steel showerhead & bowl, hand/foot operated eyewash	43.3	\$4,024.00
S19314UUZS	Halo Eyewash; plastic showerhead w/ stainless steel shroud & bowl, hand/foot operated eyewash	43	\$3,868.00
S19314BFSSZ	Halo Stainless steel eye/face wash, showerhead and bowl, barrier free	43.3	\$4,339.00
S19314FSSZ	Halo Stainless steel eye/face wash & showerhead	43.3	\$4,217.00
S19314SCZ	Halo Stainless steel eye/face wash, bowl & hinged dust cover	43.3	\$4,567.00
S19314SSZ	Halo Stainless steel eye/face wash, bowl, hinged dust cover and foot activation	45	\$4,767.00
S19314SS16Z	Halo 316 Stainless steel eye/face wash, bowl, hinged dust cover and foot activation	45	\$4,923.00

Note: All prices are shown in US dollars





List Price

Effective Date February 1, 2024

## Classic Pre-configured Units

MODELS			
Model No.	Description	Ship Wt. (lbs)	Price
<b>S19-220 Wall Mounted Eye and Eye/Face Wash Units</b>			
S19-220HFP8	Eyewash; frostproof, stainless steel bowl, behind-wall valve, 0"-8" wall thickness	22	\$1,064.00
S19-220HFP12	Eyewash; frostproof, stainless steel bowl, behind-wall valve, 8"-12" wall thickness	22	\$1,064.00
S19-220HFP18	Eyewash; frostproof, stainless steel bowl, behind-wall valve, 12"-18" wall thickness	22	\$1,064.00
<b>S19-310 Combination Drench Shower/Eyewash Units</b>			
S19-310PVC	Eye/face wash; plastic showerhead & bowl with PVC pipe construction	29	\$2,631.00
S19-310TW8	Eyewash; plastic showerhead, frost-proof, behind-wall valves, 0"-8" wall thickness	42	\$2,001.00
S19-310TW12	Eyewash; plastic showerhead, frost-proof, behind-wall valves, 8"-12" wall thickness	42	\$2,001.00
S19-310TW18	Eyewash; plastic showerhead, frost-proof, behind-wall valves, 12"-18" wall thickness	42	\$2,001.00



## Value Based Pre-configured Units

MODELS			
Model No.	Description	Ship Wt. (lbs)	Price
<b>Eye/Face Wash Units</b>			
S19-212	Eye/face wash; plastic bowl, pedestal-mounted, unpainted pipe	17	\$422.00
S19-212B	Eye/face wash; stainless steel bowl, pedestal-mounted, unpainted pipe	20	\$546.00
S19-222	Eye/face wash; plastic bowl, wall-mounted, unpainted pipe	6	\$317.00
S19-222B	Eye/face wash; stainless steel bowl, wall-mounted, unpainted pipe	7	\$404.00
<b>Combination Drench Shower/Eyewash Units</b>			
S19-312	Eye/face wash; plastic showerhead & bowl, unpainted pipe	41	\$994.00
S19-312B	Eye/face wash; plastic showerhead, stainless steel bowl, unpainted pipe	49	\$1,109.00





List Price

Effective Date February 1, 2024

**Series S19-110 Free-Standing Drench Showers**  
**Series S19-120 Horizontal Supply Drench Showers**  
**Series S19-130 Vertical Supply Drench Showers**

MODELS			
Model No.	Description	Ship Wt. (lbs)	Price
S19-110	Plastic showerhead	35	\$838.00
S19-110BF	Barrier-free, plastic showerhead	35	\$906.00
S19-110BFSS	Barrier-free, all stainless steel, corrosion-resistant	45	\$2,968.00
S19-110SS	All stainless steel, corrosion-resistant	45	\$2,955.00
S19-120	Plastic showerhead	7	\$391.00
S19-120A	Plastic showerhead with stainless steel shroud	8	\$502.00
S19-120ABF	Barrier-free, plastic showerhead with stainless steel shroud	8	\$678.00
S19-120BF	Barrier-free, plastic showerhead	7	\$527.00
S19-120FM	Flush-mounted plastic showerhead with steel shroud	8	\$712.00
S19-120FMBF	Barrier-free, flush-mounted plastic showerhead	8	\$967.00
S19-120G	Cord-operated, plastic showerhead	7	\$544.00
S19-120HFP8	Plastic showerhead, frost-proof, 0"-8" wall thickness	8	\$826.00
S19-120HFP12	Plastic showerhead, frost-proof, 8"-12" wall thickness	8	\$826.00
S19-120HFP18	Plastic showerhead, frost-proof, 12"-18" wall thickness	8	\$826.00
S19-120P	Plastic showerhead w/8' hand-held drench hose	12	\$728.00
S19-120SS	All stainless steel, corrosion-resistant	9	\$1,196.00
S19-120SSBF	Barrier-free, all stainless steel, corrosion-resistant	9	\$1,367.00
S19-120T	Stainless steel showerhead w/chrome-plated red brass pipe & fittings	9	\$972.00
S19-130	Plastic showerhead	5	\$383.00
S19-130A	Plastic showerhead, stainless steel shroud	6	\$499.00
S19-130ABF	Barrier-free, stainless steel showerhead	6	\$673.00
S19-130BF	Barrier-free, plastic showerhead	5	\$521.00
S19-130F	Cord-operated, plastic showerhead	5	\$540.00
S19-130SS	All stainless steel, corrosion-resistant	7	\$1,181.00
S19-130SSBF	Barrier-free, all stainless steel, corrosion-resistant	7	\$1,352.00

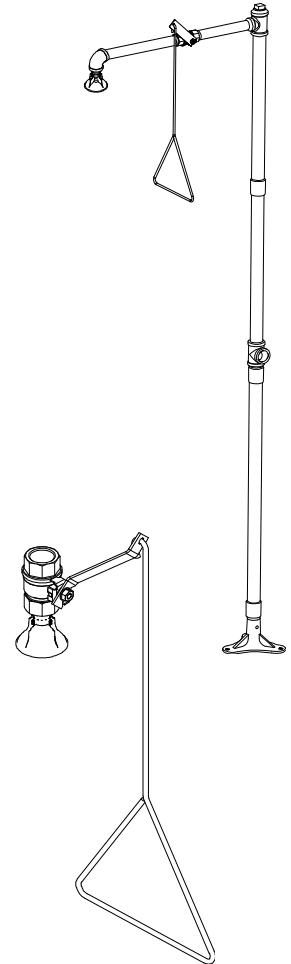



List Price

Effective Date February 1, 2024

## European Models

**Series S19-110 Free-Standing Drench Showers with BSPP Connection**

**Series S19-120 Horizontal Supply Drench Showers with BSPP Connection**

**Series S19-130 Vertical Supply Drench Showers with BSPP Connection**

MODELS			
Model No.	Description	Ship Wt. (lbs)	Price
S19-110BFSSZ	Barrier-free, all stainless steel, corrosion-resistant	45	\$3,031.00
S19-110SSZ	All stainless steel, corrosion-resistant	45	\$3,017.00
S19-120SSZ	All stainless steel, corrosion-resistant	9	\$1,258.00
S19-120SSBFZ	Barrier-free, all stainless steel, corrosion-resistant	9	\$1,388.00
S19-130SSZ	All stainless steel, corrosion-resistant	7	\$1,244.00
S19-130SSBFZ	Barrier-free, all stainless steel, corrosion-resistant	7	\$1,414.00

**Note: All prices are shown in US dollars**

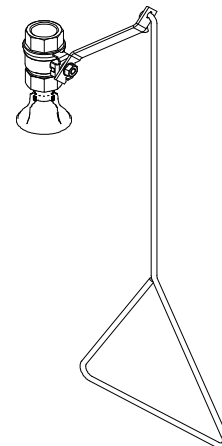
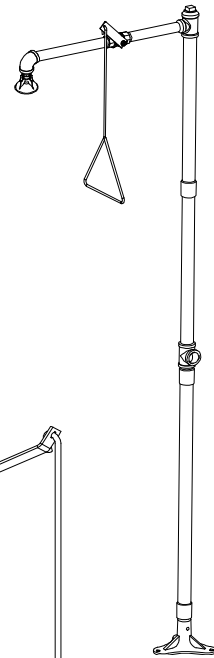



List Price

Effective Date February 1, 2024

# Barrier-Free Recessed Drench Showers, Eyewashes, Eye/Face Washes and Combination Units

MODELS			
Model No.	Description	Ship Wt. (lbs)	Price
S19-125BF	Barrier-free recess-mounted drench shower w/ a recess-mounted handle and extended showerhead	18	\$1,074.00
S19-125FMBF	Barrier-free recess-mounted drench shower w/ a recess-mounted handle and flush-mounted showerhead	18	\$1,061.00
S19284H	Cabinet-mount swing-down Halo eyewash	18	\$1,749.00
S19284J	Cabinet-mount swing-down Halo eye/face wash	19	\$1,792.00
S19284HB	Barrier-free cabinet-mount swing-down Halo eyewash	22	\$1,588.00
S19294HB	Barrier-free, cabinet concealed swing down Halo eyewash with tailpiece	39	\$2,715.00
S19294HBT	Barrier-free, cabinet concealed swing down Halo eyewash with p-trap	39	\$2,762.00
S19284JB	Barrier-free cabinet-mount swing-down Halo eye/face wash	24	\$1,628.00
S19294JB	Barrier-free cabinet-concealed swing-down Halo eye/face wash	39	\$2,841.00
S19294JBT	Barrier-free cabinet-concealed swing-down Halo eye/face wash with p-trap	41	\$2,896.00
S19345HXB	Barrier-free recessed drench shower & Halo eyewash with recessed shower handle, extended showerhead & tailpiece	105	\$4,579.00
S19345HFB	Barrier-free recessed drench shower & Halo eyewash with recessed shower handle, flush-mounted showerhead & tailpiece	57	\$4,579.00
S19345HXBT	Barrier-free recessed drench shower & Halo eyewash with recessed shower handle, extended showerhead & p-trap	57	\$4,604.00
S19345HFBT	Barrier-free recessed drench shower & Halo eyewash with recessed shower handle, flush-mounted showerhead & p-trap	57	\$4,604.00
S19345JXB	Barrier-free recessed drench shower & Halo eye/Face wash with recessed shower handle, extended showerhead & tailpiece	72	\$4,681.00
S19345JFB	Barrier-free recessed drench shower & Halo eye/face wash with recessed shower handle, flush-mounted showerhead & tailpiece	72	\$4,681.00
S19345JXBT	Barrier-free recessed drench shower & Halo eye/face wash with recessed shower handle, extended showerhead & p-trap	72	\$4,711.00
S19345JFBT	Barrier-free recessed drench shower & Halo eye/face wash with recessed shower handle, flush-mounted showerhead & p-trap	72	\$4,711.00

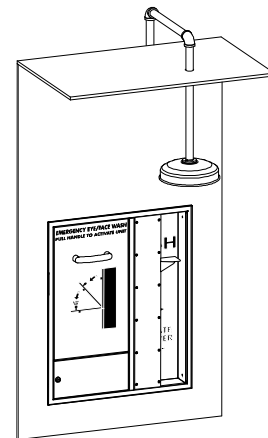
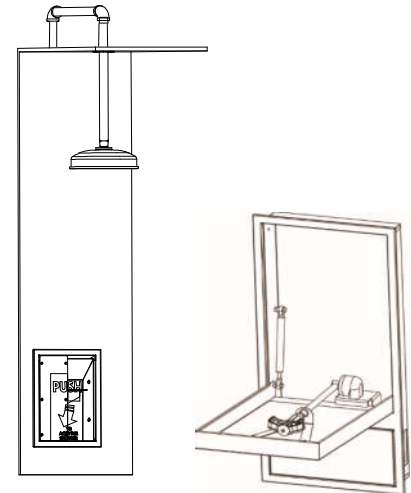



List Price

Effective Date February 1, 2024

# Series S19-200, -230, -240, -244, -260, -270, -274

## Faucet-Mounted, Unmounted, Deck-Mounted and Wall-Mounted Eye and Eye/Face Wash Fixtures

### MODELS

Model No.	Description	Ship Wt. (lbs)	Price
S19-200B	Faucet-mount eyewash	3	\$130.00

### HALO MODELS

S19-244	Halo Eyewash, less bowl	3	\$433.00
S19-244FW	Halo Eye/Face Wash, less bowl	3	\$489.00
S19-274B	Swing-Away Halo Eyewash, Right-Hand Mount	4	\$575.00
S19-274BL	Swing-Away Halo Eyewash, Left-Hand Mount	4	\$603.00
S19274C	Swing-activated Halo eyewash	5	\$514.00
S19-274F	Swing-Away Halo Eye/Face Wash, Right-Hand Mount	4	\$631.00
S19-274FL	Swing-Away Halo Eye/Face Wash, Left-Hand Mount	4	\$659.00
S19274E	Swing-activated Halo eye/face wash	5	\$562.00
S19274HD	Deck-mount swing-down Halo eyewash	5	\$785.00
S19274HDR	Deck-mount swing-down Halo eyewash, reduced length	5	\$785.00
S19274HDS	Deck-mount swing-down Halo eyewash, offset	5	\$785.00
S19274HW	Wall-mount swing-down Halo eyewash	5	\$785.00
S19274HWR	Wall-mount swing-down Halo eyewash, reduced length	5	\$785.00
S19274JD	Deck-mount swing-down Halo eye/face wash	5	\$833.00
S19274JW	Wall-mount swing-down Halo eye/face wash	5	\$833.00
S19274HDB	Barrier-free deck-mount swing-down Halo eyewash	7	\$1,284.00
S19274HWB	Barrier-free wall-mount swing-down Halo eyewash	7	\$1,284.00
S19274JDB	Barrier-free deck-mount swing-down Halo eye/face wash	7	\$1,329.00
S19274JWB	Barrier-free wall-mount swing-down Halo eye/face wash	7	\$1,329.00

### HALO SWING-ACTIVATED FAUCET EYEWASH

S19-500W	Deck-mount swing-activated faucet/eyewash, wristblade, right hand	21	\$1,120.00
S19-505W	Deck-mount swing-activated faucet/eyewash, wristblade, left hand	21	\$1,120.00
S19-500M	Deck-mount swing-activated faucet/eyewash, mixed, right hand	17	\$1,037.00
S19-505M	Deck-mount swing-activated faucet/eyewash, mixed, left hand	17	\$1,037.00
S19-500T	Deck-mount swing-activated faucet/eyewash, tempered, right hand	17	\$1,001.00
S19-505T	Deck-mount swing-activated faucet/eyewash, tempered, left hand	17	\$1,001.00

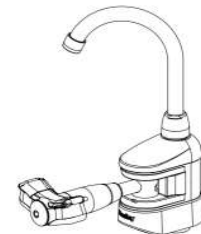
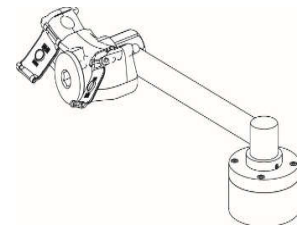
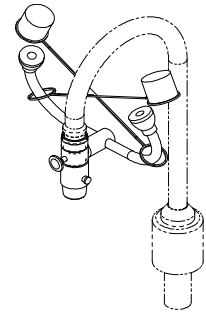



List Price

Effective Date February 1, 2024

## Series S19-304 Halo Heat Trace Combination Shower and Eyewash or Eye/Face Wash

MODELS			
Model No.	Description	Wt. (lbs)	Price
S19-304	Halo Heat Trace Combination Unit		See below
Selections (must select one from each category)			
Electrical Class			
GA	General Area	N/A	\$5,086.00
D2	Class 1, Division 2, Groups B, C, D Explosion Proof	N/A	\$6,003.00
D1	Class 1, Division 1, Groups C, D Explosion Proof	N/A	\$12,728.00
C2	Class 2, Division 1 and 2, Groups E, F, G Explosion Proof	N/A	\$6,410.00
Voltage			
V1	120V Version	N/A	N/C
V4	240V Version	N/A	N/C
Water Supply			
T	Top Supply (standard selection)	N/A	N/C
B	Bottom Supply (standard selection)	N/A	N/C
Pipe and Ball Valve Material			
GLV	Galvanized Pipe and Chrome Plated Brass Ball Valve	100	N/C
304	304 SS Pipe, 316 SS Ball Valve	100	\$2,144.00
316	316 SS Pipe, 316 SS Ball Valve	100	\$3,081.00
Showerhead			
SH	ABS Plastic Showerhead	N/A	N/C
SHP	ABS Plastic Showerhead with Plastic Shroud	N/A	\$55.00
SHS	ABS Plastic Showerhead with SS Shroud	N/A	\$115.00
S04	304 SS Showerhead	N/A	\$168.00
S16	316 SS Showerhead	N/A	\$230.00
Eyewash			
EW	ABS Plastic Eyewash, Aluminum Yoke	1	N/C
FW	ABS Plastic Eye/Face Wash, Aluminum Yoke	1	N/C
F04	304 SS Eye/Face Wash, 304 SS Yoke*	3.3	\$241.00
F16	316 SS Eye/Face Wash, 316 SS Yoke*	3.3	\$276.00
Bowl and Cover			
PP	Plastic Bowl and Cover	2	N/C
B04	304 SS Bowl and Cover	8	\$461.00
P04	304 SS Bowl and Plastic Cover	5	\$347.00
B16	316 SS Bowl and Cover	8	\$972.00
P16	316 SS Bowl and Plastic Cover	5	\$440.00
Activation			
HA	300 Series Handle Activation	1	N/C
H16	316 SS Handle Activation	1	\$78.00
HF	300 Series Handle and Foot Activation	2.2	\$112.00
HF16	316 SS Handle and Foot Activation	2.2	\$646.00
Drench Hose			
H	Drench Hose Attachment	5	\$383.00
0	No Drench Hose	N/A	N/C
Anti-Scald Valve			
S	Scald Protection Valve	3	\$768.00
0	No Scald Protection	N/A	N/C
Indicator Light (must select light to match electrical class)			
L	General Area Light, NEMA 4X	3.5	\$404.00
D2L	Class 1 Div 2 Light, NEMA 4X	3.5	\$985.00
D1L	Class 1 Div 1 Light, NEMA 4X	8	\$1,967.00
C2L	Class 2 Light, NEMA 4X	8	\$1,967.00
0	No Indicator Light	N/A	N/C
Extension Cable**			
EC	6' Extension Cable	N/A	\$112.00
0	No Extension Cable	N/A	N/C

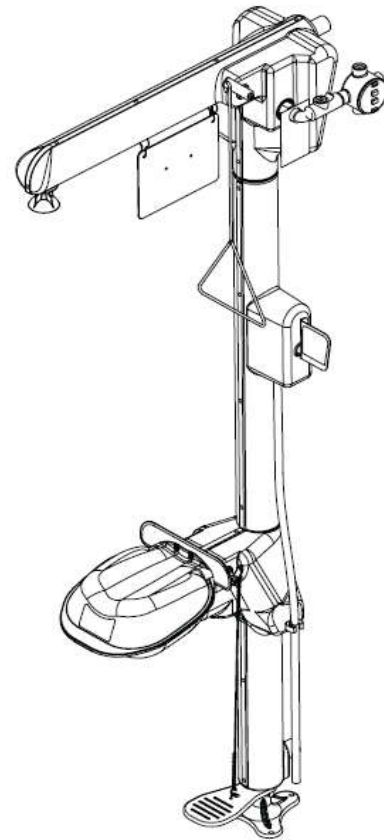

Class 1 Division 2 unit shown with Drench Hose and Foot Pedal Activation

Order signaling system separately - electrical rating should match that of heat trace unit being ordered

\*Must select stainless steel yoke if ordering 304 or 316 stainless steel pipe.

\*\*Not available with Class I, Division 1 units

Non-cancelable, non-returnable



## Series S19-304 Halo Heat Trace Combination Units Pre-Configured Models

MODELS			
Model No.	Description	Wt. (lbs)	Price
S19-304GAT	General Area, 120V, Top Supply, Galvanized Pipe, Plastic Showerhead, Plastic Bowl and Cover, 300 Series Handle Activation	104	\$5,086.00
S19-304GAB	General Area, 120V, Bottom Supply, Galvanized Pipe, Plastic Showerhead, Plastic Bowl and Cover, 300 Series Handle Activation	104	\$5,086.00
S19-304GATL	General Area, 120V, Top Supply, Galvanized Pipe, Plastic Showerhead, Plastic Bowl and Cover, 300 Series Handle Activation, General Area Indicator Lights	107.5	\$5,488.00
S19-304GABL	General Area, 120V, Bottom Supply, Galvanized Pipe, Plastic Showerhead, Plastic Bowl and Cover, 300 Series Handle Activation, General Area Indicator Lights	107.5	\$5,488.00
S19-304D2T	Class 1 Division 2 gr B, C, and D, 120V, Top Supply, Galvanized Pipe, Plastic Showerhead, Plastic Bowl and Cover, 300 Series Handle Activation	104	\$6,003.00
S19-304D2B	Class 1 Division 2 gr B, C, and D, 120V, Bottom Supply, Galvanized Pipe, Plastic Showerhead, Plastic Bowl and Cover, 300 Series Handle Activation	104	\$6,003.00
S19-304D2TL	Class 1 Division 2 gr B, C, and D, 120V, Top Supply, Galvanized Pipe, Plastic Showerhead, Plastic Bowl and Cover, 300 Series Handle Activation, Class 1 Div 2 Indicator Lights	107.5	\$6,990.00
S19-304D2BL	Class 1 Division 2 gr B, C, and D, 120V, Bottom Supply, Galvanized Pipe, Plastic Showerhead, Plastic Bowl and Cover, 300 Series Handle Activation, Class 1 Div 2 Indicator Lights	107.5	\$6,990.00

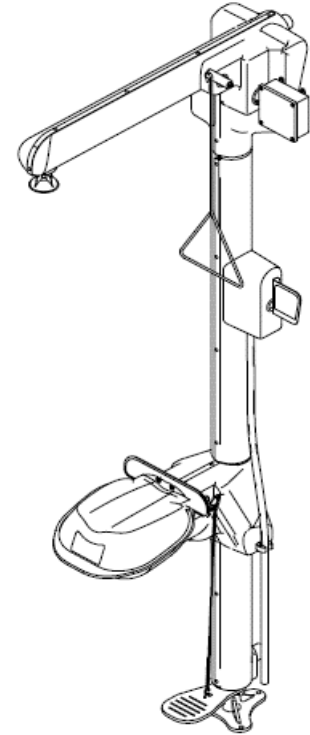

General Area unit shown with Drench Hose and Foot Pedal Activation

Order signaling system separately - electrical rating should match that of heat trace unit being ordered

Non-cancelable, non-returnable





List Price

Effective Date February 1, 2024

# Hand-Held & Recoiling Drench Hoses

MODELS			
Model No.	Description	Wt. (lbs)	Price
S19-430A	Hand-held single-head hose spray w/ 8' hose & wall holder	5	\$350.00
S19-430D	Hand-held single-head hose spray w/ 6' stainless steel hose	7	\$499.00
S19-460	Hand-held single-head hose spray w/ 8' hose, counter mounting	5	\$411.00
S19-460EFW	Hand-held dual-head hose spray w/ 8' hose, counter mounting	6	\$609.00
S19-465	Hand-held angled single-head hose spray w/ 8' hose, counter mounting bracket	5	\$493.00
S19-465EFW	Hand-held angled dual-head hose spray w/ 8' hose, counter mounting bracket	6	\$642.00
S19-430EH	Spray kit for eyewash unit	4	\$365.00
S19-430SH	Spray kit for shower unit	5	\$380.00
S1944011CBC	Hand-held face & body spray w/ 12' recoiling hose	7	\$589.00
	Hand-held face & body spray w/ 25' recoiling hose	12	\$782.00
S1944011CBD	Removable or stationary face & body spray w/ 12' recoiling hose	9	\$537.00
S1944011ABC			
S1944011BBC	Removable or stationary face & body spray w/ 12' recoiling hose and 45° sprayheads	9	\$561.00
S1944022ABC	Removable or stationary face & body spray w/ 12' recoiling hose & dual heads	10	\$689.00

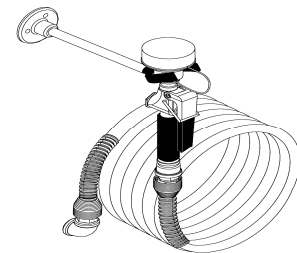
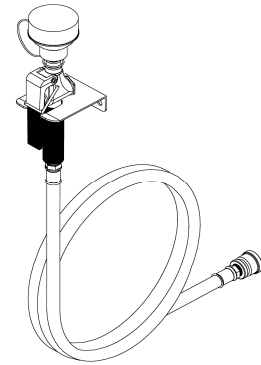



List Price

Effective Date February 1, 2024

## Series S19-670 thru 788, -865, -881, -899 Portable Eyewash Units

MODELS			
Model No.	Description	Ship Wt. (lbs)	Price
S19-670	Portable 5-gallon stainless steel pressure tank w/ 8' drench hose	20	\$1,271.00
S19-671	Portable 5-gallon stainless steel pressure tank with eyewash	20	\$1,312.00
S19-671H	Heated portable 5-gallon stainless steel pressure tank with eyewash	22	\$2,711.00
S19-671HR	Retrofit heater kit for 5-gallon stainless steel tanks with eyewash only	10	\$2,061.00
S19-672	Portable 5-gallon stainless steel pressure tank w/ eyewash & 8' drench hose	20	\$1,565.00
S19-690	Portable 10-gallon stainless steel pressure tank w/ eyewash & 8' drench hose	30	\$2,163.00
S19-690LHS	Portable 10-gallon stainless steel pressure tank with eyewash	30	\$2,068.00
S19-690H	Heated portable 10-gallon stainless steel pressure tank with eyewash	32	\$3,501.00
S19-690HR	Retrofit heater kit for 10-gallon stainless steel tanks with eyewash only	15	\$2,402.00
S19-788	Portable 15-gallon stainless steel pressure tank with eyewash & 8' drench hose	35	\$2,407.00
S19-788LHS	Portable 15-gallon stainless steel pressure tank with eyewash	35	\$2,127.00
S19-788H	Heated portable 15-gallon stainless steel pressure tank with eyewash	37	\$3,891.00
S19-788HR	Retrofit heater kit for 15-gallon stainless steel tanks with eyewash only	15	\$2,540.00
S19-690A	Stainless Steel Transport Cart	12	\$411.00
S19-921	On-Site® Gravity-Fed eyewash	23	\$468.00
S19-921H	Heated On-Site® Gravity-Fed eyewash	25	\$2,684.00
S19-921HR	Retrofit Kit for On-Site® Gravity-Fed eyewash	15	\$2,397.00
S19-399	On-Site® Waste Cart	28	\$561.00

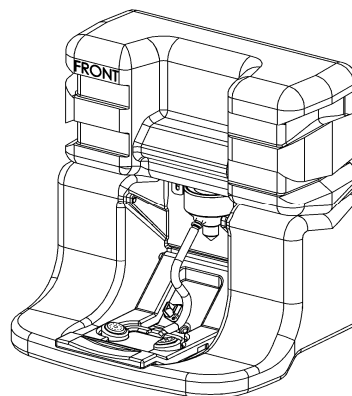
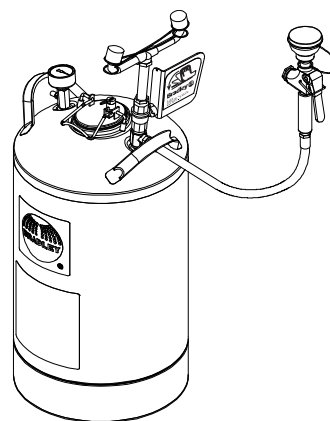



List Price

Effective Date February 1, 2024

# Navigator Thermostatic Mixing Valves Emergency Fixtures

THERMOSTATIC MIXING VALVES						
Model No.	Description	Inlet Size	Outlet Size	GPM	Ship Wt. (lbs)	List Price
S19-2000	EFX8 Thermostatic Mixing Valve	1/2"	1/2"	1.5-10.5	10	\$1,113.00
S19-2000EFX	EFX8 for Cabinet Mount Eyewash	1/2"	1/2"	1.5-10.5	10	\$1,204.00
S19-2100	EFX25 Thermostatic Mixing Valve	3/4"	1"	2.0-37.0	20	\$1,948.00
S19-2150	EFX20 Thermostatic Mixing Valve	3/4"	1"	3.0-30.5	20	\$1,862.00
S19-2200	EFX60 Thermostatic Mixing Valve	1"	1 1/4"	2.0-75.5	30	\$2,691.00
S19-2250	EFX50 Thermostatic Mixing Valve	1"	1 1/4"	3.0-65.0	30	\$2,569.00
S19-2300	EFX125 Thermostatic Mixing Valve	1 1/4"	1 1/2"	3.0-116.0	40	\$3,563.00
S19-2350	EFX120 Thermostatic Mixing Valve	1 1/4"	1 1/2"	3.0-107.0	40	\$3,405.00

OPTIONAL SELECTIONS					
Add price for appropriate option to thermostatic valve price above			Sample: <u>EFX25 - C</u>		
Model No.	Description	Rough Brass	Chrome Plated	Bracket	
Option Code		R	C	B	
S19-2000	EFX8 Thermostatic Mixing Valve	N/C	\$208.00	\$55.00	
S19-2100	EFX25 Thermostatic Mixing Valve	N/C	\$290.00	\$65.00	
S19-2150	EFX20 Thermostatic Mixing Valve	N/C	\$290.00	\$65.00	
S19-2200	EFX60 Thermostatic Mixing Valve	N/C	\$290.00	\$65.00	
S19-2250	EFX50 Thermostatic Mixing Valve	N/C	\$290.00	\$65.00	
S19-2300	EFX125 Thermostatic Mixing Valve	N/C	\$290.00	\$70.00	
S19-2350	EFX120 Thermostatic Mixing Valve	N/C	\$290.00	\$70.00	

CABINETS, PIPED ASSEMBLY, AND WINDOW OPTION						
Add price for appropriate option to thermostatic valve price above				Sample: <u>CABINET-EFX25-RS</u>		
N Piped Assembly required for Cabinet selection				Sample: <u>EFX25 - P - RS</u>		
Cabinet only option does not include valve or piped assembly				Sample: <u>EFX25 - P - RS</u>		
Must specify cabinet option code and piping option code with order						
Valve	Option	Description	Ship Wt. (lbs)	Cabinet-Only	Inlet & Outlet Shut Off Valves	No Inlet & Outlet Shut-Off Valves
				CABINET-EFX	P	N

EFX8	SS	Surface Mount Stainless Steel Cabinet w/ Piping	10	\$804.00	----	\$820.00
	RS	Recessed Stainless Steel Cabinet w/ Piping	10	\$953.00	----	\$968.00
	SE	Surface Mount White Enamel Cabinet w/ Piping	10	\$804.00	----	\$820.00
	RE	Recessed White Enamel Cabinet w/ Piping	10	\$953.00	----	\$968.00
EFX25 EFX20	P or N	P or N Piped Assembly	5	----	\$757.00	----
	SS	Surface Mount Stainless Steel Cabinet w/ Piping	25	\$1,397.00	\$2,219.00	\$1,537.00
	RS	Recessed Stainless Steel Cabinet w/ Piping	25	\$1,477.00	\$2,302.00	\$1,618.00
	SE	Surface Mount White Enamel Cabinet w/ Piping	25	\$1,397.00	\$2,219.00	\$1,537.00
EFX60 EFX50	RE	Recessed White Enamel Cabinet w/ Piping	25	\$1,477.00	\$2,302.00	\$1,618.00
	P or N	P or N Piped Assembly	10	----	\$989.00	----
	SS	Surface Mount Stainless Steel Cabinet w/ Piping	40	\$1,451.00	\$2,514.00	\$1,687.00
	RS	Recessed Stainless Steel Cabinet w/ Piping	40	\$1,593.00	\$2,660.00	\$1,829.00
EFX125 EFX120	SE	Surface Mount White Enamel Cabinet w/ Piping	40	\$1,451.00	\$2,514.00	\$1,687.00
	RE	Recessed White Enamel Cabinet w/ Piping	40	\$1,593.00	\$2,660.00	\$1,829.00
	P or N	P or N Piped Assembly	10	----	\$1,273.00	----
	SS	Surface Mount Stainless Steel Cabinet w/ Piping	40	\$1,464.00	\$2,818.00	\$2,087.00
W	RS	Recessed Stainless Steel Cabinet w/ Piping	40	\$1,681.00	\$3,042.00	\$2,305.00
	SE	Surface Mount White Enamel Cabinet w/ Piping	40	\$1,464.00	\$2,818.00	\$2,087.00
	RE	Recessed White Enamel Cabinet w/ Piping	40	\$1,681.00	\$3,042.00	\$2,305.00
	W	Plexiglass Window in Door		\$246.00	\$246.00	\$246.00

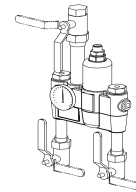

EFX25-P

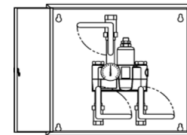

EFX-P-SS

0



List Price

Effective Date February 1, 2024

## S19-324 Series-General Area Emergency Signaling System Accessories

<b>MODELS</b>		
<b>Model No.</b>	<b>Description</b>	<b>Price</b>
S19-324	Emergency Signaling System, General Area, NEMA 4X	
<b>Options (Must choose one from each section)</b>		
<b>Base Model(s)</b>		
EF	Eye or Eye/Face Wash	\$2,563.00
DC	Drench or Combination	\$2,563.00
HT	Halo Heat Trace Combination Unit*	\$2,563.00
<b>Activation</b>		
SS	Stainless Steel Flow Switch	\$1,092.00
<b>Audible Sound</b>		
TN1	Tone 1	\$0.00
TN2	Tone 2	\$107.00
TN3	Tone 3	\$107.00
<b>Silence Switch</b>		
0	None	\$0.00
PM	Panel Mount	\$129.00
FM	Flex Mount	\$374.00
<b>Signal Light</b>		
SA	Amber (Flashing)	\$0.00
SR	Red (Flashing)	\$194.00
<b>Beacon Light</b>		
0	None	\$0.00
BG	Green (Steady)	\$731.00
BB	Blue (Steady)	\$784.00
<b>Area Light</b>		
0	None	\$0.00
AW	White (Steady)	\$731.00
AR	Red (Steady)	\$784.00
<b>Cable Length (Flow Switch to Signaling System)</b>		
C6	6' Cable	\$0.00
C12	12' Cable	\$57.00
C50	50' Cable	\$165.00

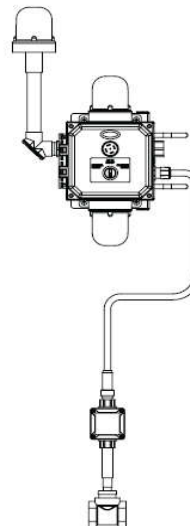

\*Signaling system can only be mounted to the new style S19-304 Halo Heat Trace Combination Unit.



List Price

Effective Date February 1, 2024

## S19-324 Series-Explosion Proof Emergency Signaling System Accessories

MODELS		
Model No.	Description	Price
S19-324D2	Class 1, Division 2, Explosion Proof Emergency Signaling System	
Options (Must choose one from each section)		
Base Model(s)		
EF	Eye or Eye/Face Wash	\$5,764.00
DC	Drench or Combination	\$5,764.00
HT	Halo Heat Trace Combination Unit*	\$5,897.00
Activation		
SS	Stainless Steel Flow Switch	\$1,123.00
Audible Sound		
TS	Standard Single Tone	\$0.00
TM	Multi-Tone (Installer Mounted)	\$4,159.00
Silence Switch**		
0	None	\$0.00
RS	Silence/Reset Switch	\$2,267.00
Signal Light		
SA	Amber (Flashing)	\$0.00
SR	Red (Flashing)	\$403.00
Beacon Light		
0	None	\$0.00
BG	Green (Steady)	\$3,117.00
BB	Blue (Steady)	\$3,255.00
Area Light		
0	None	\$0.00
AW	White (Steady)	\$3,117.00
AR	Red (Steady)	\$3,255.00
Cable Length		
C6	6' Cable	\$0.00
C12	12' Cable	\$156.00
C50	50' Cable	\$889.00

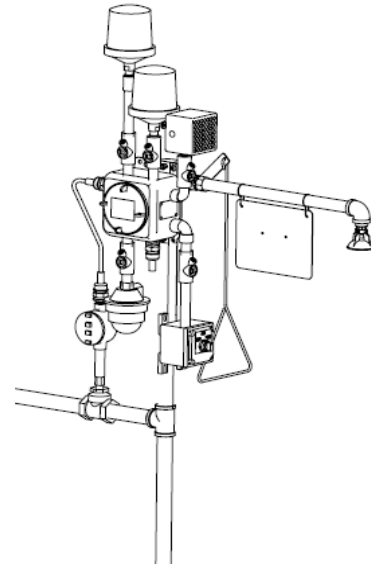

\*Signaling system can only be mounted to the new style S19-304 Halo Heat Trace Combination Unit.

\*\*Optional selection may impact electrical rating.



List Price

Effective Date February 1, 2024

# S19-324 Series-Explosion Proof Emergency Signaling System Accessories

MODELS		
Model No.	Description	Price
S19-324D1	Class I, Division 1, Explosion Proof Emergency Signaling System	
Options		
Base Model (select one)		
EF	Eye or Eye/Face Wash	\$10,967.00
DC	Drench or Combination	\$10,967.00
HT	Halo Heat Trace Combination Unit* ( <i>Mounting Bracket Included</i> )	\$11,101.00
Mounting ( <i>Skip this selection when ordering with 'HT' option</i> )		
PT	Pipe Mount	\$49.00
WM	Wall Mount	\$49.00
Activation (select one)		
SS	Stainless Steel Flow Switch	\$1,123.00
Audible Sound (select one)		
TS	Standard Single Tone	\$0.00
TM	Multi-Tone (Installer Mounted)	\$4,159.00
Silence/Reset Switch** (select one)		
0	None	\$0.00
RS	Reset Switch	\$2,616.00
Signal Light - Flashing (select one)		
SA	Amber	\$0.00
SR	Red	\$403.00
Beacon Light - Steady (select one)		
0	None	\$0.00
BG	Green	\$6,068.00
BB	Blue	\$6,345.00
Area Light - Steady (select one)		
0	None	\$0.00
AW	White	\$6,068.00
AR	Red	\$6,345.00
Cable Length (select one)		
C6	6' Cable	\$0.00
C12	12' Cable	\$132.00
C50	50' Cable	\$293.00

\*Signaling system can only be mounted to the new style S19-304 Halo Heat Trace Combination Unit.

\*\*Optional selection may impact electrical rating.



List Price

Effective Date February 1, 2024

## Pre-Configured Emergency Signaling System Accessories

MODELS			
Model No.	Description	Wt. (lbs)	Price
<b>S19-322 Series</b>			
S19-322D	Recessed Emergency Signaling System, Drench or Combination, NEMA 1	12	\$ 2,367.00
S19-322E	Recessed Emergency Signaling System, Eye or Eye/Face Wash, NEMA 1	10	\$ 2,367.00
<b>S19-323 Series</b>			
S19-323D	Emergency Signaling System, Drench or Combination, NEMA 3R	12	\$ 2,278.00
S19-323E	Emergency Signaling System, Eye or Eye/Face Wash, NEMA 3R	10	\$ 2,278.00
<b>S19-324 Series - General Area</b>			
S19-324D	Emergency Signaling System, Drench or Combination, NEMA 4X	12	\$2,692.00
S19-324E	Emergency Signaling System, Eye or Eye/Face Wash, NEMA 4X	10	\$2,692.00
S19-324DG	Emergency Signaling System, Drench or Combination, NEMA 4X, Green Beacon	14	\$3,422.00
S19-324EG	Emergency Signaling System, Eye or Eye/Face Wash, NEMA 4X, Green Beacon	13	\$3,422.00
S19-324DGW	Emergency Signaling System, Drench or Combination, NEMA 4X, Green Beacon, White Area Light	16	\$4,152.00
S19-324EGW	Emergency Signaling System, Eye or Eye/Face Wash, NEMA 4X, Green Beacon, White Area Light	15	\$4,152.00
<b>S19-324 Series - Explosion Proof</b>			
S19-324D2D	Explosion Proof Emergency Signaling System, Class I, Division 2, Drench or Combination, NEMA 4X, Signal Light	37	\$5,764.00
S19-324D2DHT	Explosion Proof Emergency Signaling System, Class I, Division 2, Drench or Combination, NEMA 4X, Signal Light, <b>for use with Heat Trace Units</b>	37	\$5,897.00
S19-324D1D	Explosion Proof Emergency Signaling System, Class I, Division 1, Drench or Combination, NEMA 4X, Signal Light, Pipe Mount	58	\$11,018.00
S19-324D1DHT	Explosion Proof Emergency Signaling System, Class I, Division 1, Drench or Combination, NEMA 4X, Signal Light, <b>for use with Heat Trace Units</b>	58	\$11,101.00

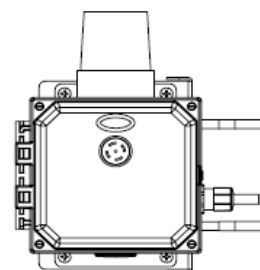
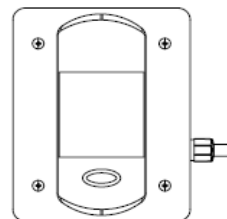

All pre-configured models include flow switch in stainless steel construction





List Price

Effective Date February 1, 2024

## Emergency Fixture Accessories

<b>MODELS</b>			
<b>Model No.</b>	<b>Description</b>	<b>Wt. (lbs)</b>	<b>Price</b>
<b>Heater Jacket Retrofit Kits for Portable Pressurized Eyewashes</b>			
S19-671HR	Heater jacket retrofit kit for 5 gallon tank	10	\$1,963.00
S19-690HR	Heater jacket retrofit kit for 10 gallon tank	15	\$2,288.00
S19-788HR	Heater jacket retrofit kit for 15 gallon tank	15	\$2,419.00
<b>Transport Cart for Pressurized Eyewash Tanks</b>			
S19-690A	Four wheel, stainless steel transport cart for pressurized eyewash tanks	12	\$404.00
<b>On-Site Heater Jacket Retrofit Kit</b>			
S19-921HR	On-site heater jacket retrofit kit (pedestal not included)	15	\$2,397.00
<b>On-Site Waste Cart</b>			
S19-399	On-site waste cart	28	\$561.00
<b>Drench Hose Spray Kits</b>			
S19-430EH	Drench hose spray kit with valve, drench hose sprayhead, hose, inspection tag, and hardware; retrofits to most eye and eye/face wash fixtures	5	\$365.00
S19-430SH	Drench hose spray kit with valve, drench hose sprayhead, hose, inspection tag, and hardware; retrofits to most drench showers or combination units	4	\$380.00
<b>Flow Switches</b>			
S19-319E	Stainless Steel, 1/2" NPT	3	\$1,388.00
S19-319D	Stainless Steel, 1 1/4" NPT	6	\$1,404.00
<b>Retrofit Classic Dust Covers</b>			
S45-1964	Plastic bowl, dust cover, gasket, and hardware; compatible with any Bradley plastic eyewash bowl	4	\$212.00
S45-2396	Stainless steel "clam shell" cover and bowl, stainless steel handle, tether, and quick release pin; for use with any Bradley eyewash bowl	4.7	\$371.00
<b>Shower Accessories</b>			
S19-330	Privacy curtain (with universal mounting) includes curtain rail and mounting brackets	14	\$790.00
S19-330ST	Drench shower tester; water-tight funnel with weighted bottom and 84" long with 8' telescoping aluminum handle	5	\$203.00

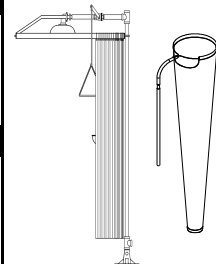
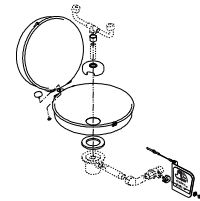



List Price

Effective Date February 1, 2024

## Replacement Parts-Classic Model

<b>MODELS</b>			
<b>Model No.</b>	<b>Description</b>	<b>Wt. (lbs)</b>	<b>Price</b>
<b>Eyewash Ball Valves, Handles, and Hardware</b>			
S30-070	Stainless steel eyewash handle with 1/2" NPT stay-open ball valve and hardware	1	\$102.70
S30-072	Stainless steel handle with 1/2" NPT stay-open ball valve and hardware - for stainless steel hinged dust covers only	1	\$114.70
S30-074	Stainless steel handle with 1/2" NPT stay-open ball valve and hardware - left hand activation kit	1	\$138.20
S45-122	Plastic eyewash handle with 1/2" NPT stay-open ball valve and hardware	0.7	\$88.50
128-135	Plastic handle only	0.2	\$27.20
S08-336	Stainless steel handle only; vertical valve applications only	0.4	\$46.90
S08-338	Stainless steel handle only; horizontal valve applications only	0.5	\$85.30
S30-071	Stainless steel handle, hardware	0.5	\$59.50
S30-075	Stainless steel handle, hardware, for S19-270BL eyewash only, left handed activation conversion kit for pedestal mounted or combination fixtures	1	\$102.70
S30-087	Stainless steel handle, hardware, for stainless steel hinged dust covers only	1	\$79.30
S45-123	Plastic handle, hardware	0.2	\$36.90
S27-282	Chrome-plated brass 1/2" ball valve	0.4	\$49.20
S30-109	Stainless steel eyewash handle with 1/2" stainless steel NPT stay-open ball valve	1.15	\$292.80
S30-110	Stainless steel eyewash handle with 1/2" vented stainless steel NPT stay-open ball valve	1.15	\$303.30
S30-111	316 stainless steel eyewash handle with 1/2" stainless steel NPT stay-open ball valve	1.15	\$336.80
S30-112	Stainless steel eyewash handle with dust cover with 1/2" stainless steel NPT stay-open ball valve	1.15	\$304.50
S30-116	316 stainless steel eyewash handle with hardware	1.15	\$116.70
S08-056	Stainless steel eyewash handle with dust cover and hardware	0.5	\$77.30
<b>Sprayhead and Spray Ring Assemblies</b>			
S45-2453	Eye/face wash (sprayheads only)	0.2	\$96.00
S39-394	Eyewash sprayhead assembly with supply stem	0.5	\$235.30
S39-396	Eye/face wash sprayhead assembly with supply stem	0.7	\$288.00
S39-681	Eye/face wash sprayhead assembly; stem not included	0.6	\$163.50
S39-682	Eye/face wash assembly for use with PVC unit only; stem not included	0.7	\$438.50
S39-397	Eyewash and spray ring assembly with supply stem	2	\$467.20
<b>Dust Caps</b>			
107-371	Eyewash dust caps only, sold individually (need two per eyewash), yellow plastic tether, 1" x 1"	0.1	\$7.50
S53-063	Dual eye/face wash dust caps only, sold individually (need two per eyewash), beaded chain tether, 2 1/4" x 1"	0.1	\$16.70
S53-310	Eyewash dust cap, sold individually (need two per eyewash), beaded chain tether, 1" x 1", not for use with portable pressurized tank eyewashes	0.02	\$17.60
<b>Eyewash Bowls</b>			
154-058	Impact-resistant plastic eyewash bowl, 10" diameter	0.6	\$ 54.40
187-053	Corrosion-resistant stainless steel bowl, 10 3/4" diameter	1.2	\$ 148.10
<b>Stem Spacers</b>			
113-1159	Stainless steel stem spacer; for use in units with stainless steel bowl	0.02	\$ 10.90
113-1185	Black plastic stem spacer; for use in units with yellow plastic bowl	0.004	\$ 5.50

Prices subject to change without notice.  
Items may be changed or discontinued  
without notice and without incurring obligation.



List Price

Effective Date February 1, 2024

## Replacement Parts-Classic Model

<b>MODELS</b>			
<b>Model No.</b>	<b>Description</b>	<b>Wt. (lbs)</b>	<b>Price</b>
<b>Stem Assemblies</b>			
S21-071	Brass stem assembly with flow restrictor; for units with eyewash only	0.2	\$ 25.90
S21-072	Stainless steel stem assembly with flow restrictor; for stainless steel units with eyewash only	0.2	\$ 55.90
S21-073	Brass stem assembly with flow restrictor; for units with eyewash and spray ring only	0.2	\$ 34.40
S21-074	Stainless steel stem assembly with flow restrictor; for stainless steel units with eyewash and spray ring only	0.2	\$ 57.80
S21-075	316 stainless steel stem assembly with flow restrictor; for 316 stainless steel units (with eyewash only)		\$ 96.90
113-1150	Brass stem only; for units with dual black eye/face wash heads	0.1	\$ 17.90
113-1151	Stainless steel stem only; for stainless steel units with dual black eye/face wash heads	0.2	\$ 43.90
<b>Eyewash and Eye/Face Wash Flow Restrictors</b>			
125-032	3.5 GPM black flow restrictor; for swing-activated and swing down units	0.001	\$ 6.80
125-167	3.7 GPM pink flow restrictor; for eyewash with face spray ring only (stem not included)	0.005	\$ 4.20



List Price

Effective Date February 1, 2024

## Replacement Parts-Halo Models

<b>MODELS</b>			
<b>Model No.</b>	<b>Description</b>	<b>Wt. (lbs)</b>	<b>Price</b>
<b>Covers and Bowls Kits</b>			
187-320	Plastic bowl	1.1	\$ 63.60
S90-388	Stainless steel bowl cover kit	4	\$ 408.50
S90-390	Plastic bowl cover kit	1	\$ 152.60
S90-391	Stainless steel bowl kit	8.3	\$ 520.00
S90-392	Stainless steel bowl kit; 316 stainless steel	8.3	\$ 771.40
<b>Sprayhead Assemblies</b>			
S05-190	Eyewash sprayhead assembly with dust covers	0.2	\$ 62.80
S05-192	Eye/face wash sprayhead assembly with dust covers	0.4	\$ 90.30
S05-204	304 stainless steel eye/face wash assembly with dust covers	2.7	\$ 706.90
S05-205	316 stainless steel eye/face wash assembly with dust covers	2.7	\$ 815.70
<b>Dust Cover Kits</b>			
S45-2675	Eyewash cover kit	0.1	\$ 26.40
S45-2676	Eye/face wash cover kit	0.1	\$ 37.70
<b>Handle Kit</b>			
S08-390	Handle kit	1	\$ 120.10
<b>O-Ring and Flow Control</b>			
S65-339	O-ring and screen assembly	0.002	\$ 17.20
S88-068	O-ring screen and flow control	0.3	\$ 55.20
<b>Ball Valves</b>			
S27-327	Chrome-plated brass 1/2" ball valve	0.5	\$ 52.50
S27-328	Stainless steel 1/2" ball valve	0.6	\$ 242.20



List Price

Effective Date February 1, 2024

## Replacement Parts-Spintec Showerhead and Drench Shower Parts

<b>MODELS</b>			
<b>Model No.</b>	<b>Description</b>	<b>Wt. (lbs)</b>	<b>Price</b>
<b>Drench Shower Handle for Standard Units</b>			
128-156A	Drench shower handle for standard units; 27-3/4" pull rod only; standard pull rod shipped with non-barrier-free showers	0.6	\$ 53.60
128-157	Drench shower handle; 27-3/4" pull rod only, 316SS	0.7	\$ 108.80
128-156B	Drench shower handle for flush-mount units; 36" pull rod only	0.8	\$ 81.40
<b>Drench Shower Handle for Barrier-Free Units</b>			
128-156C	Drench shower handle; 48" pull rod only	1.2	\$ 95.70
128-156D	Drench shower handle; 45 1/2" pull rod only; standard pull rod shipped with barrier-free showers	1.1	\$ 100.10
128-156E	Drench shower handle; 57" pull rod only	1.5	\$ 110.90
128-156F	Drench shower handle; 69" pull rod only	1.8	\$ 113.90
<b>SpinTec Showerhead Retrofit Kits</b>			
S24-192	Plastic shroud and ring (showerhead not included)	0.7	\$ 27.30
S24-193	Stainless steel shroud and ring (showerhead not included)	1.3	\$ 87.20
S24-194	Plastic showerhead and 1" diameter 90° elbow	0.9	\$ 50.60
S24-195	Plastic shroud with ring, plastic showerhead and 1" diameter 90° elbow	1.45	\$ 102.70
S24-196	Stainless steel shroud with ring, plastic showerhead and 1" diameter 90° elbow	2.05	\$ 167.00
S24-200	Stainless steel showerhead and 1" diameter 90° elbow	1.4	\$ 213.60
S24-202	Plastic showerhead, white steel in-ceiling recessed shroud assembly, ring, coupling and 1" diameter 90° elbow	2.05	\$ 236.40
154-147	Ring only	0.1	\$ 1.50
<b>Drench Shower Ball Valve</b>			
S27-278	Chrome-plated brass 1" NPT ball valve only	1.2	\$ 94.70
S30-059	Chrome-plated brass 1" NPT ball valve with lever	1.4	\$ 162.40
S30-061	Stainless steel 1" NPT ball valve with lever	1.2	\$ 396.60
<b>Self-Closing Ball Valve</b>			
S19-0011	Self-closing ball valve	1.5	\$ 190.70



List Price

Effective Date February 1, 2024

## Replacement Parts-Drench Hose

<b>MODELS</b>			
<b>Model No.</b>	<b>Description</b>	<b>Wt. (lbs)</b>	<b>Price</b>
<b>Drench Hose Replacement Part Valve</b>			
S39-817	Replacement valve with drench hose sprayhead	1.3	\$ 241.50
<b>Hoses</b>			
S89-002	8' thermoplastic hose; yellow	1	\$ 180.50
S89-003	6' stainless steel hose	2.5	\$ 346.50
269-053	12' thermoplastic hose; yellow	1.5	\$ 302.50
269-054	25' thermoplastic hose; yellow	3	\$ 549.40
<b>Hose Guide Bracket</b>			
140-226	Drench hose guide bracket; mounts under deck	0.8	\$ 33.60
<b>Backflow Prevention</b>			
S27-303	Dual-check backflow preventer, Series 7	0.85	\$ 312.20
S45-2309	Dual check vacuum breaker, Series 9	0.95	\$ 438.00
S45-2310	Dual check backblow preventer, includes fittings for installation, Series 9D	1.55	\$ 539.50



List Price

Effective Date February 1, 2024

## Replacement Parts-Other

<b>MODELS</b>			
<b>Model No.</b>	<b>Description</b>	<b>Wt. (lbs)</b>	<b>Price</b>
<b>On-Site Portables</b>			
S19-949	On-site eyewash refill kit (includes replacement cap, nine foam liners, inspection tag)	2	\$ 21.00
269-1379	On-site water foam liner (sold individually)	0.001	\$ 3.70
133-152	Tank for S19-921 unit	4.1	\$ 186.10
<b>Safety Signs and Tags</b>			
114-050	Drench shower sign	0.2	\$ 33.50
114-051	Eyewash sign	0.2	\$ 33.50
114-052	Combination drench shower and eyewash sign	0.2	\$ 33.50
<b>Optional Adapters</b>			
153-395	Female, 13/16 x 24-Brass	0.2	\$ 22.60
153-396	Male, 3/8 IPS-Brass	0.2	\$ 22.60
153-401	Female, 3/4 (garden hose)-Brass	0.2	\$ 24.40
<b>Foot Treadle Kits</b>			
S39-395	Foot treadle and hardware kit for wall-mounted eyewashes with hand operation; provides supplemental foot operation	2	\$ 302.30
S45-572	Foot treadle and hardware kit (with 3 foot chain) for standard pedestal-mounted eyewashes and combination shower/eyewash units with hand operation; provides supplemental foot operation	1.3	\$ 121.00
S45-620	Foot treadle and hardware kit for model S19-310PVC combination drench shower and eyewash unit with hand operation; provides supplemental foot operation	1.6	\$ 462.10
S45-1314SS	Type 304 stainless steel foot treadle and hardware kit for stainless steel pedestal-mounted eyewashes and combination shower/eyewash units	2	\$ 526.50
S45-1314SS16	Type 316 stainless steel foot treadle and hardware kit for Type 316 stainless steel pedestal-mounted eyewashes and combination shower/eyewash units	2	\$ 684.60
S45-1544	Foot treadle and hardware kit (with 3 1/2 foot chain) for European units with hand operation; supplemental foot operation	2	\$ 119.70
<b>Freeze Protection Kits</b>			
S45-1986	Freeze protection kit for eyewashes	2.25	\$ 988.20
S45-1987	Freeze protection kit for drench showers	2.25	\$ 984.00
<b>Scald Protection Kits</b>			
S45-1989	Scald protection kit for eyewashes	2.25	\$ 988.20
S45-1990	Scald protection kit for drench showers	2.25	\$ 984.00
<b>Replacement Valves</b>			
S45-1703	Freeze protection replacement valve for drench showers and eyewashes	1	\$ 907.00
S45-1702	Scald protection replacement valve for drench showers and eyewashes	0.9	\$ 912.60
<b>Miscellaneous Supplies</b>			
269-964	Safety yellow touch-up paint	0.1	\$ 77.30
204-421	Inspection tag (sold individually)	0.02	\$ 3.50
269-1444	Eyewash test gauge	0.7	\$ 24.30



## Change Log

<b>Date</b>	<b>Page</b>	<b>Change Description</b>	<b>Implemented By</b>
12/1/2018	All	2019 Price Update	David Quale
1/30/2019		Add S19274HWR	David Quale
1/30/2019		Add S19-2000EFX	David Quale
11/18/2019		Removed S19-125SBF & SFMBF	V. Bonney
11/18/2019		Removed Keltech Pages	V. Bonney
7/30/2020		Removed S27-276, updated EFX Service Parts Pricing	V. Bonney
11/17/2020		Removed S05-127, updated EFX Service Parts Pricing	V. Bonney
7/8/2021		Removed 128-156G, updated EFX Service Parts Pricing	V. Bonney
3/13/2022		Updated CDN MULT	V Bonney
11/21/2023		2024 Price Increase	V. Bonney

**\*Unless noted, all changes apply to both US and CDN price book pages**